

1:10TH SCALE BRUSHED ELECTRIC MOTOR POWERED TROPHY TRUCK



## EXPLODED DRAWINGS AND COMPONENT LISTING

ENGLISH INSTRUCTIONS – PAGE 2  
FRANÇAIS INSTRUCTIONS – PAGE 11



[www.ftx-rc.com](http://www.ftx-rc.com)



# fastrax

## PERFORMANCE ACCESSORIES

### FASTRAX BLACK ALUM LOCKING ROTATING CAR MAINTENANCE STAND w/MAGNET

FAST407BK Black  
FAST407B Blue



FASTRAX ROUND FINNED MOTOR HEATSINK  
FAST36



M4 FLANGED NYLOC NUTS (4)  
FTM4BF (blue)    FTM4BKF (black)  
FTM4GF (gold)    FTM4PF (pink)  
FTM4PU (purple)    FTM4RF (red)

FASTRAX LARGE SHOULDER CARRY BAG  
FAST677



FASTRAX 19-in-1 TOOL BAG 3xSLOT, 3x PH 6xHEX, 4xNUT 1x5/8mm WRENCH  
FAST607



FASTRAX ALUMINIUM 32 LED LIGHT BAR w/MOUNTS 150MM WIDE  
FAST2342



PERFORMANCE ACCESSORIES THAT GIVE YOU THE RACING EDGE

[www.fastrax-rc.com](http://www.fastrax-rc.com)

CML PRODUCTS ARE AVAILABLE IN ALL GOOD MODEL & HOBBY SHOPS. CHECK OUR WEBSITE FOR FULL DETAILS  
[WWW.CMLDISTRIBUTION.CO.UK](http://WWW.CMLDISTRIBUTION.CO.UK)



Send An A4 SAE for FREE Catalogue:





# EXPLODED PARTS DIAGRAM

**B O M**

TYPE	ICON	SPEC	QTY
Round Head Self Tapping Hex Screw		2x10	4
Button Head Hex Screw		M3x8	2
		M3x10	2
		M3x12	3
Cap Head Hex Screw		M3x8	4
		M3x20	2
		M3x8	2
Flat Head Hex		M3x10	10
		M3x12	3
		M3x1.6	4
		M3x1.8	2
		M3x2.5	2
		M3x3.5	2
Set Screw		M4x4	1
Ring Self Tapping Screw		M4x10	2
		M4x4	2
Washer		a6x0.1x0.2	2
Nylon Lock Nut		M3	2
E clip		a0.5	5
O Ring		a0.05x0.05x0.1.05	4
		a0.05x0.05x0.1.05	4
Ball Bearing		a15.0x12.0x4.0	2
		a15.0x12.0x4.0	2

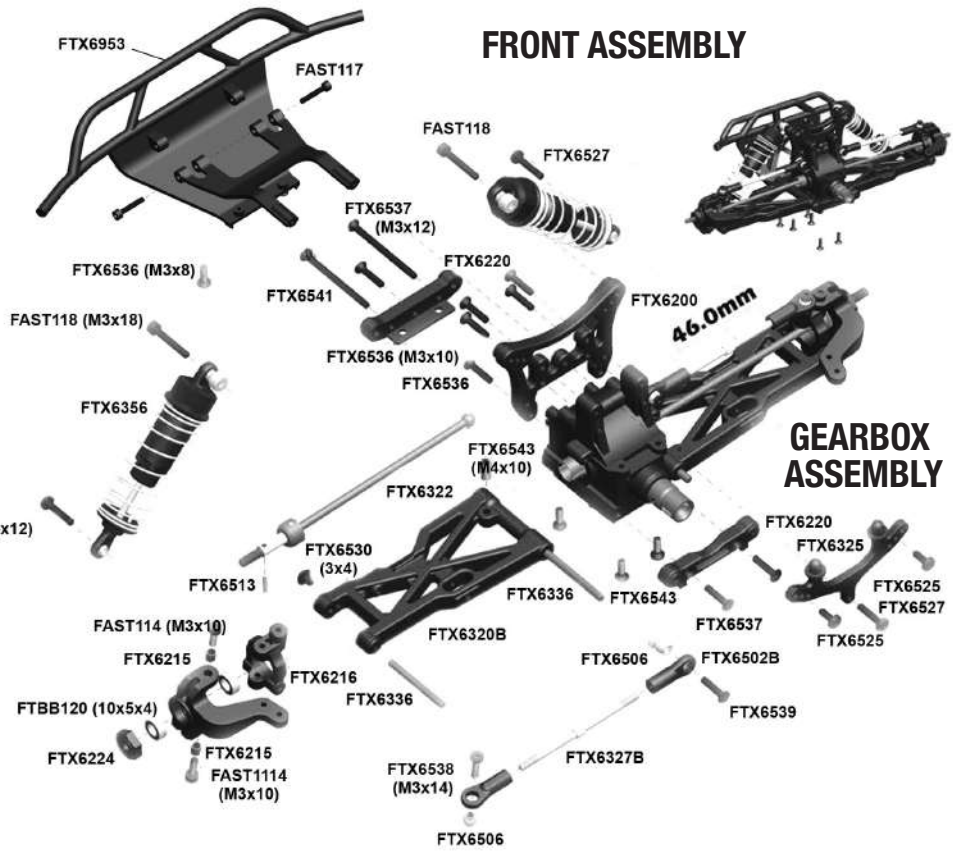

## GEARBOX ASSEMBLY

## STEERING ASSEMBLY

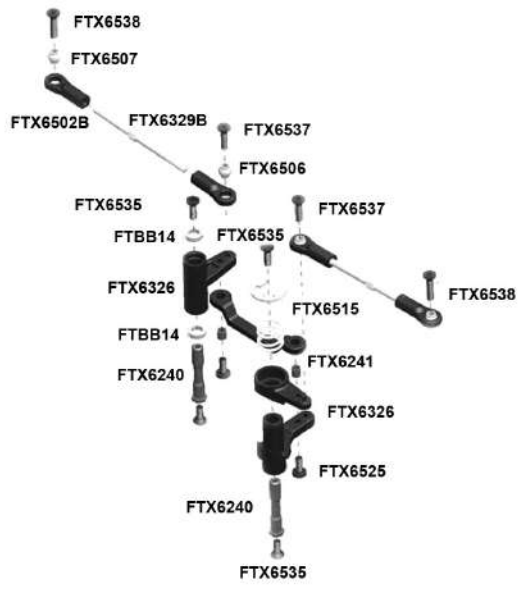

## SERVO ASSEMBLY

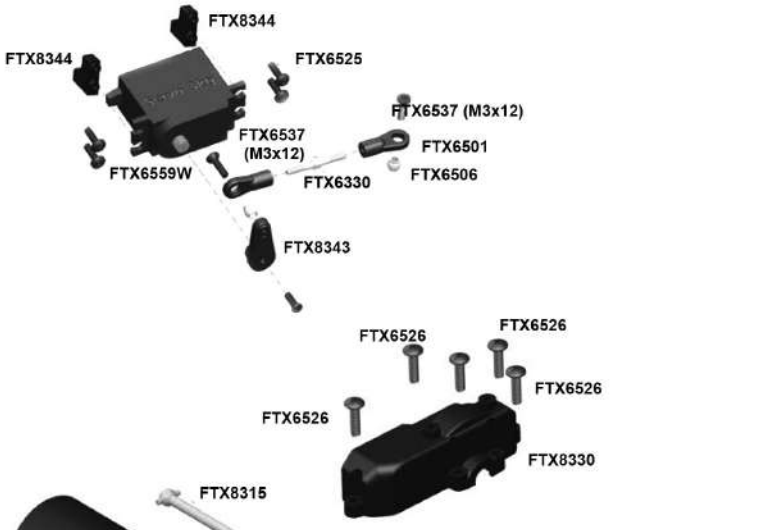

## CENTRAL TRANSMISSION

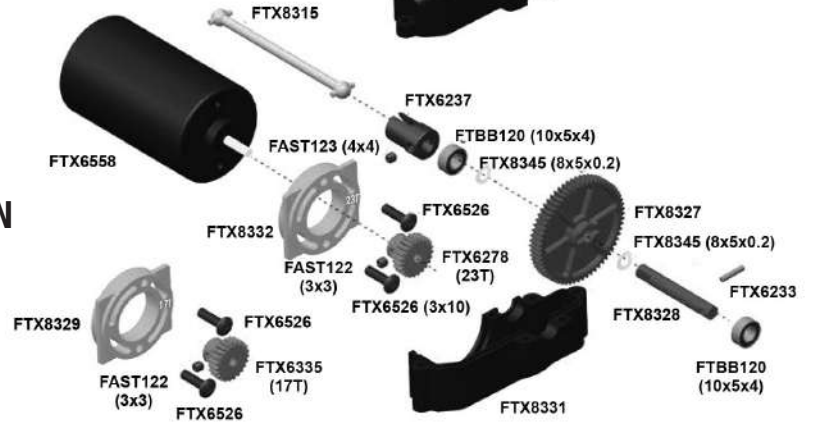





# EXPLODED PARTS DIAGRAM

## CHASSIS ASSEMBLY

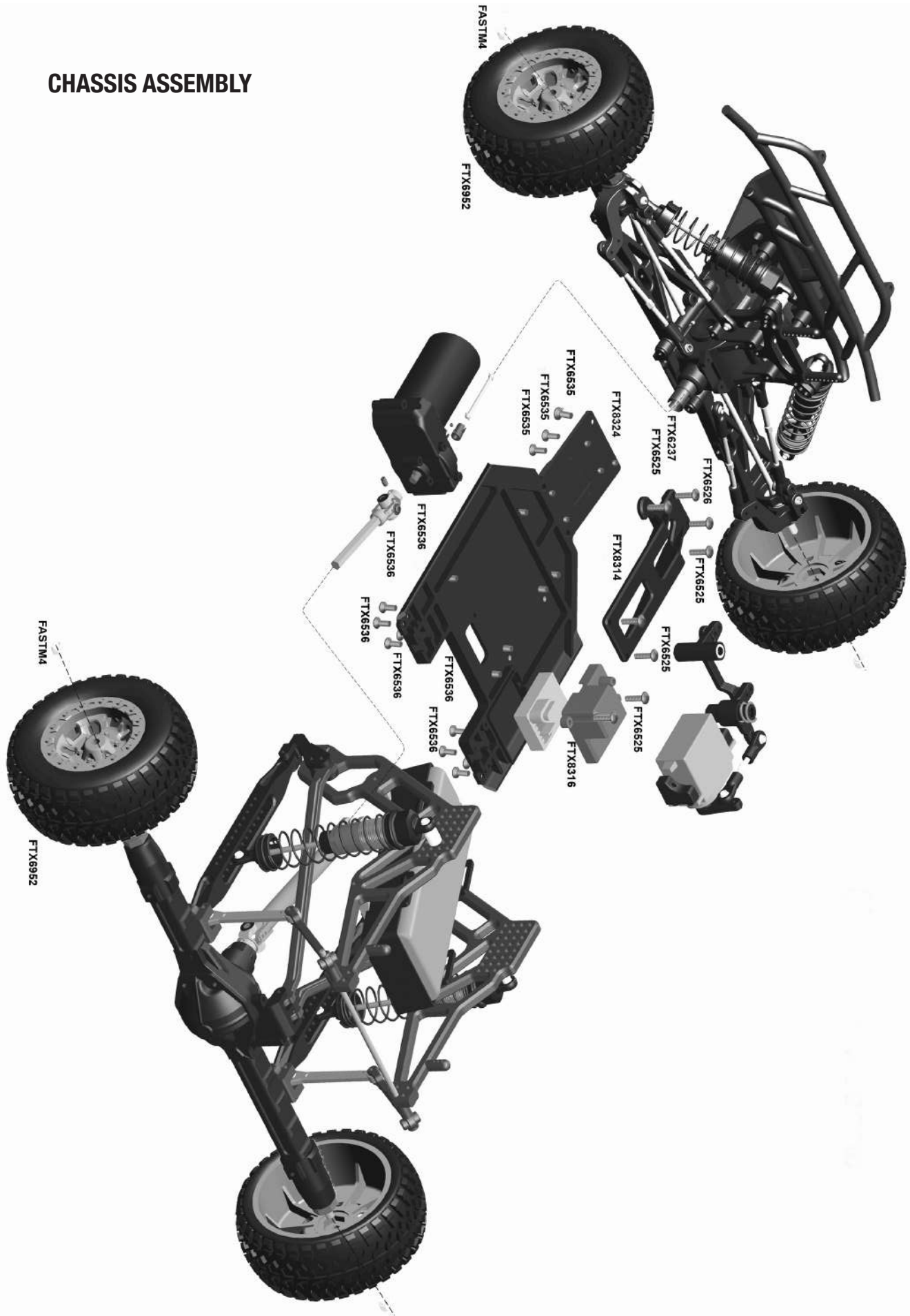





# SPARE PARTS LISTING

<p><b>Front Bumper 1 pc</b> FTX6953</p> 	<p><b>Front Shocks 2pc(AL)</b> FTX6356</p> 	<p><b>Rear Shocks 2pc (Al)</b> FTX8349</p> 	<p><b>Front Shock Spring 2pc</b> FTX6204</p> 
<p><b>Rear Shock Spring 2pc</b> FTX8312</p> 	<p><b>Front Shock Shaft &amp; Piston Set 2sets</b> FTX6206</p> 	<p><b>Rear Shock Shaft &amp; Piston Set 2sets</b> FTX8340</p> 	<p><b>Front Shock Body 2pc (AL)</b> FTX8347</p> 
<p><b>Shock Lower holder &amp; Adjust Ring 2sets</b> FTX6212</p> 	<p><b>Rear Shock body 2pc (Al)</b> FTX8341</p> 	<p><b>Shock Upper Cap 2sets</b> FTX6210</p> 	<p><b>Shock Lower Caps 2sets</b> FTX6211</p> 
<p><b>Front Lower Susp. Arm 2pc</b> FTX6320B</p> 	<p><b>Steering Knuckle Arm 1set</b> FTX6215</p> 	<p><b>Uprights 2pc</b> FTX6216</p> 	<p><b>Front CVD 2pc</b> FTX6322</p> 
<p><b>Front Susp. Holders 2pc</b> FTX6220</p> 	<p><b>Front shock Tower</b> FTX6200</p> 	<p><b>Gearbox Housing Set 2pcs</b> FTX6225</p> 	<p><b>Diff 16T Gear Washer 6pcs</b> FTX6226</p> 
<p><b>Diff. Drive Gear w/pin 2sets</b> FTX6227</p> 	<p><b>Diff Gearbox Set 1set</b> FTX6236</p> 	<p><b>Diff Case 2pcs</b> FTX6228</p> 	<p><b>Diff Drive Spur Gear 2pcs</b> FTX6229</p> 



# SPARE PARTS LISTING

<p>Diff Drive Gear 2pcs <b>FTX6230</b></p> 	<p>Diff Bevel Gear S. 4pcs <b>FTX6231</b></p> 	<p>Diff Bevel Gear B. 4pcs <b>FTX6232</b></p> 	<p>Diff Pin 2pcs <b>FTX6233</b></p> 
<p>Washer 6pcs <b>FTX6234</b></p> 	<p>Diff Drive Cup 4pcs <b>FTX6235</b></p> 	<p>Center Coupler 3pcs <b>FTX6237</b></p> 	<p>Body Post 2pcs <b>FTX6236</b></p> 
<p>FTX Strap 2pcs <b>FTX8346</b></p> 	<p>Servo Saver Post 2pcs <b>FTX6240</b></p> 	<p>Steering Ackerman <b>FTX6241</b></p> 	<p>Front Upper Susp. Arm 2sets <b>FTX6327B</b></p> 
<p>Steering Arm 2sets <b>FTX6329B</b></p> 	<p>Servo Linkage 1pc <b>FTX6330</b></p> 	<p>Wheel Hub 4pcs <b>FTX6224</b></p> 	<p>Antenna Pipe Set 2sets <b>FAST103B</b></p> 
<p>Servo Saver (EP) 1set <b>FTX6326</b></p> 	<p>Shock Ball End (6pcs) <b>FTX6500</b></p> 	<p>Metal Bushing 8*5*2.5 6pc <b>FTBB14</b></p> 	<p>Servo Horns <b>FTX8343</b></p> 
<p>Servo Post 2sets <b>FTX8344</b></p> 	<p>Pinion Gear 17T (EP) 1pc <b>FTX6335</b></p> 	<p>Body Clip (Medium Size) 6pcs <b>FTX6551</b></p> 	<p>Body Clip (Small Size) 6pcs <b>FTX6550</b></p> 



# SPARE PARTS LISTING

<p>Roll cage Top Frame <b>FTX8300</b></p> 	<p>Roll cage side Frame 2pcs <b>FTX8301B</b></p> 	<p>Roll cage Front 1pc <b>FTX8302</b></p> 	<p>Roll cage rear plate 1pc <b>FTX8303</b></p> 
<p>Rearlink holder <b>FTX8304</b></p> 	<p>Rear Central CVD rear half <b>FTX8305</b></p> 	<p>Spare wheel support <b>FTX6960</b></p> 	<p>Roll cage window frame 1pc <b>FTX8307B</b></p> 
<p>Rearaxle housing <b>FTX8308</b></p> 	<p>Rear axle cover <b>FTX8309</b></p> 	<p>Axle adaptor 2pcs <b>FTX8310</b></p> 	<p>Rear holder for rear shock support rod 2pcs <b>FTX8311</b></p> 
<p>Battery case <b>FTX8339</b></p> 	<p>Rear link set 2pcs <b>FTX8313B</b></p> 	<p>Upper plate <b>FTX8314</b></p> 	<p>Front central drive shaft 1pc <b>FTX8315</b></p> 
<p>Receiver box cover <b>FTX8316</b></p> 	<p>Rear drive Shaft short 1pc <b>FTX8317</b></p> 	<p>Rear drive Shaft long 1pc <b>FTX8318</b></p> 	<p>Trailing arm chassis mounts (2) <b>FTX8319</b></p> 
<p>Sway bar <b>FTX8320</b></p> 	<p>Battery case holder 2pcs <b>FTX8321</b></p> 	<p>Main frame 2pcs <b>FTX8322</b></p> 	<p>Rear trailing arms (2) <b>FTX8323B</b></p> 



# SPARE PARTS LISTING

Main Chassis  
FTX8324



Upper Sway Bar Link  
FTX8325



Lower Sway Bar Link  
FTX8326



Main Gear 62T  
FTX8327



Central Driveshaft  
FTX8328



Upper Transmission Cover  
FTX8330



Lower Transmission Cover  
FTX8331



Motor Mount for 17T Pinion  
FTX8329



Rear Centre Driveshaft Front half  
FTX8333



Wheels (pr)  
FTX6950



Tyres & Foam (pr)  
FTX6951



Mounted Wheels & Tyres (pr)  
FTX6952



Printed Body Blue  
FTX6965B



Printed Body Orange  
FTX6965O



Clear body  
FTX6964



Drive helmet  
FTX8336B  
FTX8336R



Driver Interior  
FTX8337



Rear Diff Shaft  
FTX8338



Pinion Gear 23T  
FTX6278





















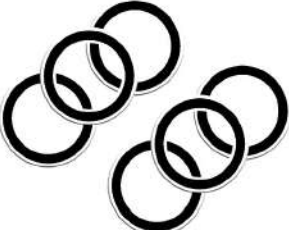
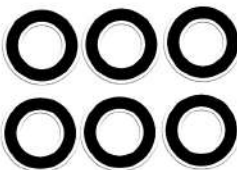



Ball Bearing 11x5x4mm  
FTBB11

Ring Self Tapping Screw  
2.5x3m (4pc)  
FTX6534

# SPARE PARTS LISTING



<p>Servo Link Ball End 6pcs <b>FTX6501</b></p> 	<p>Steering Linkage Ball End 6pcs <b>FTX6502 (BLACK) FTX6502B (BLUE)</b></p> 	<p>Ball A 6pcs <b>FTX6506</b></p> 	<p>Ball B 6pcs <b>FTX6507</b></p> 
<p>Ball C 6pcs <b>FTX6508</b></p> 	<p>Shock O-ring (Lower) 6pcs <b>FTX6510</b></p> 	<p>Diff O-ring Seal 6pcs <b>FTX6511</b></p> 	<p>Shock seal cover 4pcs <b>FTX6512</b></p> 
<p>Pin <math>\phi</math>2*10 6pcs <b>FTX6513</b></p> 	<p>Hinge Pins (long &amp; short) 2sets <b>FTX6336</b></p> 	<p>Ball Bearing 15*10*4 6pcs <b>FTBB10</b></p> 	<p>Ball Bearing 10*5*4 6pcs <b>FTBB16</b></p> 
<p>8x5x0.2mm Washer (6pc) <b>FTX8345</b></p> 	<p>Ball Bearing 8*5*2.5 6pcs <b>FTBB14</b></p> 	<p>E clip-8mm 4pc <b>FTX6515</b></p> 	<p>E clip-4mm 6pc <b>FTX6516</b></p> 
<p>E clip-2.5mm 6pc <b>FTX6517</b></p> 	<p>Nylon Lock Nut M3 6pc <b>FASTM3</b></p> 	<p>Nylon Lock Nut-M4 6pc <b>FASTM4</b></p> 	<p>Round Head Self Tapping Hex Screw 2*6 4pcs <b>FTX6518</b></p> 
<p>Round Head Self Tapping Hex Screw 2*10 6pc <b>FTX6519</b></p> 	<p>Round Head Self Tapping Hex Screw 3*15 8pc <b>FTX6520</b></p> 	<p>Round Head Self Tapping Hex Screw M3*6 6pc <b>FTX6522</b></p> 	<p>Button Head Hex Screw M3*8 6pc <b>FTX6525</b></p> 

# SPARE PARTS LISTING



<p>Button Head Hex Screw M3*10 6pc <b>FTX6526</b></p>	<p>Button Head Hex Screw M3*12 6pc <b>FTX6527</b></p>	<p>Button Head Hex Screw M3*14 6pc <b>FTX6528</b></p>	<p>Ring Self Tapping Screw 3*4 4pc <b>FTX6530</b> Ring Self Tapping Screw 3*6 6pc <b>FTX6531</b></p>
<p>Set Screw M3*3 6pc <b>FAST122</b></p>	<p>Set Screw M4*4 6pc <b>FAST123</b></p>	<p>Button Head Hex Screw M4*10 6pc <b>FTX6543</b></p>	<p>Set Screw M3*10 6pc <b>FTX6545</b></p>
<p>Cap Head Hex Screw M3*8 6pc <b>FAST114</b></p>	<p>Cap Head Hex Screw M3*10 6pc <b>FTX6542</b></p>	<p>Cap Head Hex Screw M3*10 6pc <b>FAST115</b></p>	<p>Cap Head Hex Screw M3*14 6pc <b>FTX6532</b></p>
<p>Cap Head Hex Screw M3*15 6pc <b>FAST117</b></p>	<p>Cap Head Hex Screw M3*18 6pc <b>FAST118</b></p>	<p>Cap Head Hex Screw M3*25 6pc <b>FAST119</b></p>	<p>Cap Head Hex Screw M3*28 6pc <b>FTX6533</b></p>
<p>Flat Head Hex M3*6 6pc <b>FTX6544</b></p>	<p>Flat Head Hex M3*8 6pc <b>FTX6535</b></p>	<p>Flat Head Hex Screw M3*10 8p <b>FTX6536</b></p>	<p>Flat Head Hex Screw M3*12 6p <b>FTX6537</b></p>
<p>Flat Head Hex Screw M3*14 6p <b>FTX6538</b></p>	<p>Flat Head Hex Screw M3*18 3p <b>FTX6539</b></p>	<p>Flat Head Hex Screw M3*20 6p <b>FTX6540</b></p>	<p>Flat Head Hex Screw M3*36 6p <b>FTX6541</b></p>



# OPTION PARTS LISTING

<p>Front Shock Tower (Carbon) 1Set <b>FTX6361</b></p> 	<p>Steering Ackerman (AL) 1pc <b>FTX6360</b></p> 	<p>Front Lower Susp. Arm (AL) 2pc <b>FTX6368</b></p> 	<p>Front Suspension Holders (AL) 1pc <b>FTX6361</b></p> 
<p>Battrey case holder (Al) <b>FTX8370</b></p> 	<p>Aluminium Knuckle Arm 2pc <b>FTX6368</b></p> 	<p>Wheel Hub (AL) 4pc <b>FTX6365</b></p> 	<p>Heatsink 1pc <b>FTX6373</b></p> 
<p>Alum Steering Arm 2pc <b>FTX6367</b></p> 	<p>Alum Motor mount (For 17T) 1pc <b>FTX8371</b></p> 	<p>AL Motor mount (For 23T) 1pc <b>FTX8372</b></p> 	<p>Chassis plate (Al) Chassis plate (carbon) 1pc <b>FTX8373</b></p> 
<p>Swaybar pull rod upper (Al) 2pc <b>FTX8375</b></p> 	<p>Swaybar pull rod lower (Al) 2pc <b>FTX8376</b></p> 	<p>Rear Central CVD Front half (steel) 1pc <b>FTX8377</b></p> 	<p>Front holder for Rear Shock Support rod (Al) 2pcs <b>FTX8378</b></p> 
<p>Rear Shocks lower Support rod (Al) <b>FTX8379</b></p> 	<p>Main frame (Al) 2pcs <b>FTX8380</b></p> 	<p>Rear link holder (Al) <b>FTX8381</b></p> 	<p>AL rear link set 2pcs <b>FTX8382</b></p> 
<p>Axle adaptor (Al) <b>FTX8383</b></p> 	<p>Upper plate (Al) <b>FTX8384</b></p> 	<p>Rear AXle housing (Al) <b>FTX8385</b></p> 	<p>Rear holder for rear shock support rod (Al) <b>FTX8386</b></p> 
<p>Alum rear Axle <b>FTX8387</b></p> 	<p>Alum Rim 2pcs <b>FTX8388</b></p> 	<p>Chassis Plate Carbon 1pc <b>FTX8374</b></p> 	



# ETRONIX - YOUR NO.1 SOURCE FOR R/C ELECTRONICS

**NEW**

## ETRONIX POWERPAL 3.0 AC/DC PERFORMANCE CHARGER/DISCHARGER (UK PLUG)

ET202 (UK Plug)  
ET202E (EU Plug)



## ETRONIX POWERPAL PEAK PLUS AC 1/3/5Amp CHARGER

ET202 (UK Plug)



**voltz**  
[www.voltz-rc.com](http://www.voltz-rc.com)



**VOLTZ BATTERIES**  
OLTZ 3200MAH 2S 7.4V 40C HARDCASE  
LIPO STICK BATTERY PACK  
VZ0305

## ETRONIX SPORT TUNED MODIFIED MOTORS

Etronix Sport Tuned Modified  
15T Brushed Motor  
ET0305

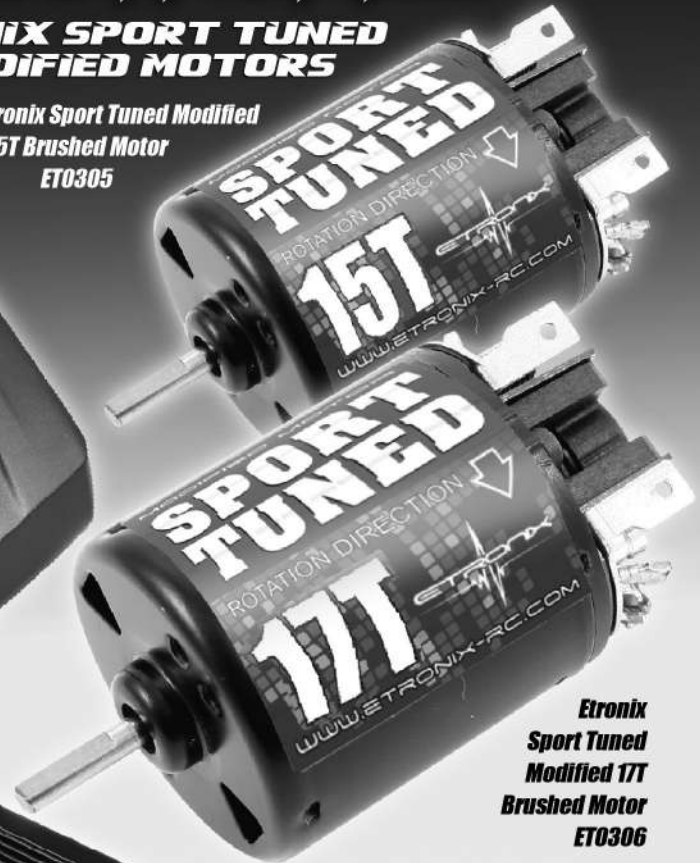

Etronix  
Sport Tuned  
Modified 17T  
Brushed Motor  
ET0306

## ETRONIX SERVOS

ETRONIX 20.3kg/0.16s STANDARD DIGITAL SERVO METAL GEAR  
ET2049



ETRONIX  
20.3kg/0.12s STD DIGITAL  
HIGH VOLTAGE SERVO METAL GEAR  
ET2062

**ETRONIX**  
MODEL ELECTRONICS  
[www.etrnix-rc.com](http://www.etrnix-rc.com)

E&OE.

CML PRODUCTS ARE AVAILABLE IN ALL GOOD MODEL & HOBBY SHOPS. CHECK OUR WEBSITE FOR FULL DETAILS  
[WWW.CMLDISTRIBUTION.CO.UK](http://WWW.CMLDISTRIBUTION.CO.UK)



FTX  
TORRO  
TROPHY TRUCK  
EP



[www.ftx-rc.com](http://www.ftx-rc.com)



FTX is an exclusive brand of CML Distribution, Saxon House, Saxon Business Park,  
Hanbury Road, Bromsgrove, Worcestershire, B60 4AD England.  
E-mail: [info@ftx-rc.com](mailto:info@ftx-rc.com)