

1:10TH SCALE BRUSHLESS
OFF ROAD RACING TRUCK

CARNAGE

BRUSHLESS 2.0



INSTRUCTION BOOK AND COMPONENT LISTING

ENGLISH INSTRUCTIONS – PAGE 2
FRANÇAIS INSTRUCTIONS – PAGE 12



www.ftx-rc.com





FTX Carnage 2.0 Brushless 1/10th Scale 4WD Electric Powered Ready-To-Run Off Road Truck

Congratulations on your purchase of the FTX 'Carnage 2.0 Brushless' electric off road Monster Truck.

This 1/10th scale model has been factory assembled and all electrics installed and set up to make it the easiest possible introduction to the sport of driving RC cars.

WARNING: Read the ENTIRE instruction manual to become familiar with the features of the product before operating.

Failure to operate the product correctly can result in damage to the product, personal property and cause serious injury.

This is NOT a toy and must be operated with caution and common sense.

Failure to operate this product in a safe and responsible manner could result in damage, injury or damage to other property.

This product is not intended for use by children without direct adult supervision.

It is essential to read and follow all the instructions and warnings in the manual, prior to assembly, set-up or use, in order to operate correctly and avoid damage or serious injury.



Safety Precautions and Warnings

- You are responsible for operating this model such that it does not endanger yourself and others, or result in damage to the product or the property of others.
- This model is controlled by a radio which is possibly subject to interference which can cause momentary loss of control so it is advisable to always keep a safe distance to avoid collisions or injury.
- Age Recommendation: 14 years or over. This is not a toy. This product is not intended for use by children without direct adult supervision.

Carefully follow these directions and warnings, plus those of any additional equipment associated with the use of this model, chargers, ESC and motors, radio etc.

- Never operate your model with low transmitter batteries.
- Always operate your model in an open area away from cars, traffic or people.
- Never operate the model in the street or in populated areas.
- Always keep the vehicle in direct line of sight, you cannot control what you cannot see!
- Keep all chemicals, small parts and anything electrical out of the reach of children.
- Although splash-proof the car and electronics are not designed to be subjected to extended moisture exposure or submersion. To do so will result in permanent damage.
- Avoid injury from high speed rotating parts, gears and axles etc.
- Novices should seek advice from more experienced people to operate the model correctly and meet its performance potential.
- Exercise caution when using tools and sharp instruments.
- Do not put fingers or any objects inside rotating and moving parts.
- Take care when carrying out repairs or maintenance as some parts may be sharp.
- Do NOT touch equipment such as the motor, electronic speed control and battery, immediately after using your model because they can generate high temperatures.
- Always turn on your transmitter before you turn on the receiver in the car. Always turn off the receiver before turning your transmitter off.
- Keep the wheels of the model off the ground, and keep your hands away from the wheels when checking the operation of the radio equipment.
- Prolong motor life by preventing overheat conditions.
Undue motor wear can result from frequent turns, rapid change of direction forwards/backwards, continuous stop/starts, pushing/pulling objects, driving in deep sand and tall grass, or driving continuously up hill.

Contents:

FTX Carnage 2.0 Brushless Truck
Transmitter: 2.4ghz Steerwheel
Charger: 2S/3S 800mA Balance
Battery: 3250mAh 7.4V 2S LiPo
Voltz LiPo Safety Charge Sack





REQUIRED EQUIPMENT FOR OPERATION

1. Tools required for building and maintenance:

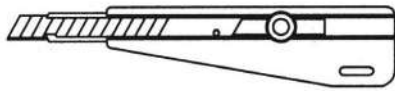

● Hobby knife



● Precision ruler

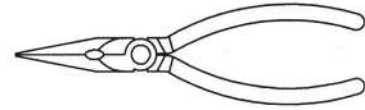

● Needle nose pliers

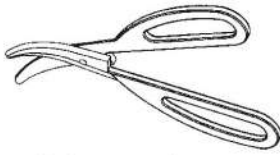

● Lexan scissors

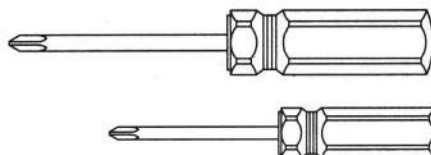

● Flat and Philips screwdriver

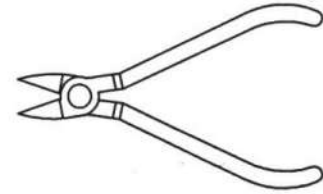

● Wire cutters

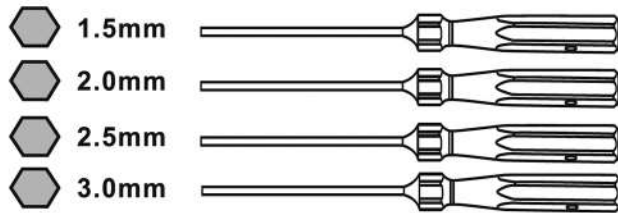

Hex. Screwdrivers

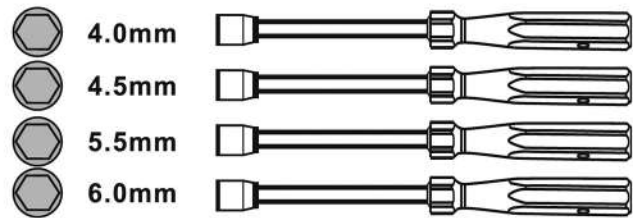

Socket Head Drivers

WARNING!

Do not use a power screw driver to install screws into nylon or plastic materials. The fast locking may heat up the screws being installed that may break the molded parts or strip the threads during installation.

2. Additional items needed for operation:

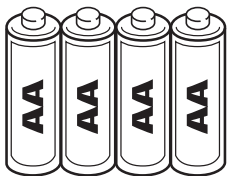

4 pcs AA Alkaline Batteries

IMPORTANT!

Check that all screws and nuts are tight before each use.



CHARGING/INSTALLING THE BATTERY

IMPORTANT! ALWAYS CHARGE IN A LIPO SACK OR TIN AWAY FROM FLAMMABLE MATERIALS (SUCH AS CARPET). ALWAYS MONITOR CHARGE STATUS INCASE YOU NEED TO STOP WITH IMMEDIATE EFFECT AND ALWAYS STORE YOUR MODEL WITH THE BATTERY UNPLUGGED AND REMOVED.

The included 900mAh mains LiPo balance charger will take up to 2.5 hours to re-charge the LiPo battery depending on how discharged it is. Before you start charging ensure that your LiPo battery is put inside the Voltz Vault safety LiPo sack.

(Lipo batteries can be dangerous and must be handled with care. Before commencing with charging ensure you familiarise yourself with our safety guidelines at within within the manual and on the base of the battery. Failure to do so could result in injury or damage. Lipo batteries require completely different charging and care than NiCd and NiMH batteries and must be used with a LiPo specific charger. Misuse can result in fire, personal injury and/or damage to property. The user assumes all liability and risk associated with the use of Lithium-Polymer (Li-Po) batteries. Immediately return the battery, unused, if you do not agree with these terms).

WARNING! NEVER LEAVE THE BATTERY UNATTENDED WHILE ON CHARGE.

- The supplied charger can charge either 2s or 3s (cell number) LiPo batteries. The supplied battery is a 2s. Ensure you plug it into the correct 2s balance port.
- When the charger is connected to the mains power the three power LED's will turn green. Once you connect your balance connector to the charger the status LED's will turn Red indicating that charging is in progress (2 LED for 2S battery and 3 LED for 3S). Once the battery is fully charged the status LED's will turn green. If you experience the LED's blinking red then there is an error with either the battery or charger. When charging a completely discharged battery, the charger can become hot to touch.
- Always disconnect the charger from the mains supply and the battery pack when not in use.
- To install a charged battery into the vehicle, remove the body clips and remove the bodyshell. Loosen the velcro straps, insert battery and then tighten the straps so that they securely hold the battery inside the battery box. Make

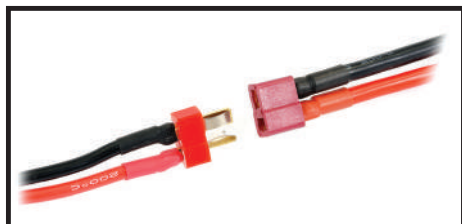

sure the model is switched off before connecting the male and female connectors.

- Always store your model with the battery pack unplugged and removed. Always charge your battery away from the vehicle. The included 300mAh mains charger will take approx 6 hours to charge a fully discharged battery, but always remove it from the charger if it becomes warm to the touch. Always disconnect the charger from the mains supply and the battery pack when not in use. Keep children away from charger and battery during the charging process.
- To install a charged battery, remove the body clips and remove the bodyshell. Remove the battery retainer clips, insert battery and re-install retainer with the flat side facing the battery and re-insert clips. When connecting battery and turning car on, ensure it is off the ground, with wheels away from objects.

Notes on Battery use:

- Always allow the battery cool after use, before recharging.
- Always inspect the battery before charging.
- Any bare wires, split heat shrink or leakage is a sure sign of abuse.
- Never attempt to charge dead or damaged batteries.
- Do not disassemble the battery or cut the connector wires.

- If the battery connector, battery case or cable insulation get hot enough to melt or split there is most likely a serious problem with your model, driveline, battery wires or speed controller. Find and correct the problem before installing another charged battery pack. (please refer to our detailed LiPo handling notes below).

LIPO BATTERY - USER SAFETY AND HANDLING INSTRUCTIONS.

- Read all safety instructions before charging or using your batteries for the first time.
- Lipo batteries require completely different charging and care than NiCd and NiMH batteries.
- Misuse can result in fire, personal injury and/or damage to property.
The buyer assumes all liability and risk associated with the use of Lithium-Polymer (Li-Po) batteries. Immediately return the battery, unused, if you do not agree with these terms.

General guidelines and warnings:

1. Use a Lithium Polymer specific chargers only! Do not use a NiCd or NiMH charger.
2. NEVER charge unattended. Always charge in safety sack or metal tin with lid and away from other flammable materials.
3. During the charge process watch for swollen or ballooning cells. If this happens immediately disconnect the charger and move the battery to a fire proof place for 15 minutes. Do not attempt to charge again.
4. A short circuit can cause a rapid discharge of high currents. Avoid short circuits, and be aware of short circuits on jewellery.
5. Any Lithium Polymer battery involved in a crash should be removed and observed in a fireproof space for 15 minutes before continuing to use or charge the battery.
6. If rewiring the battery pack, rewire the leads one at a time. Do not cut both leads. Do not short circuit on tools.
7. Do not expose battery packs to direct sunlight for extended periods.
8. Do not attempt to tamper with or open the LiPo Hardcase. The case is protection against possible battery swelling.

Before charging:

Visually inspect the pack checking for damaged leads, connectors, cracked heat shrink covering, swelling or other abnormalities. Do not charge if the pack is damaged.

Charging process:

1. NEVER charge unattended.
2. Charge away from flammable materials and inside a Lipo safe sack or metal tin with lid.
3. Allow battery to cool before charging.
4. Use the battery label for setting charger cell count and voltage.
5. Do not exceed 5C MAX charge rate. (Example, charge a 1000mAH pack at 5A MAX).

If disposing of a LiPo battery proceed as follows: Submerge the battery into a container filled with about 10 litres of salt water (one cup of salt in 10L). Leave the battery submerged for 2 weeks, this will slowly and safely discharge the battery until the voltage has dropped to zero volts which eliminates the risk of any chemical reaction. It can then be disposed of in the general waste collection.



OPERATING THE ELECTRONIC SPEED CONTROLLER

Thank you for your purchasing this Etronix product, the Photon 3.0 ESC is our new generation brushless electronic speed controller (RTR version). The high power systems for RC models can be very dangerous, we strongly suggest that you read this manual carefully before using your speed control. Etronix have no control over the use, installation, application, or maintenance of these products, thus no liability shall be assumed nor accepted for any damages, losses of costs resulting from the use of this item.

Caution

- Do not let children use this product without the supervision of an adult.
- The ESC might get hot during use, be careful when handling it.
- When soldering input/output wires and connections, set the iron to 60W minimum.
- Always disconnect the battery after use, do not store with the battery connected.
- Do not use near flammable materials.
- If the ESC overheats, emits smokes or burns, immediately discontinue use, disconnect the battery and seek assistance.

Features

- Completely water-proof and dust-proof.
- 32-bit microprocessor can support more powerful processing capability and more accurate motor output.
- Excellent start-up, acceleration and linearity features.
- Multiple protection features: Low voltage cut-off protection, over-heat protection and throttle signal loss protection.
- Be easily programmed with LED Program Card.

Specification

Product Name	Photon 3.0 50A G2	Photon 3.0 60A G2	Photon 3.0 120A SCT G2	Photon 3.0 150A G2
Cont. Current	50A	60A	120A	150A
Burst Current	300A	390A	780A	950A
Input Voltage	2-3S Lipo	2-3S Lipo	2-4S Lipo	2-6S Lipo
BEC Output	6V/3A(Switch BEC)	6V/3A(Switch BEC)	6V/3A(Switch BEC)	6V,7.4V/6A(Switch BEC)
Size(L*W*H)	48*38*32.5mm	48*38*32.5mm	56.5*38*33.5mm	55*48*37.5
Weight	94g	95.5g	100g	150g
ESC Programming Via	LED Program Card	LED Program Card	LED Program Card	LED Program Card
Firmware Upgrade	Not Supported	Not Supported	Not Supported	Not Supported
Waterproof	Supported	Supported	Supported	Supported
Car Applicable	1/10th Touring Cars/Buggies/ Trucks/Monster Trucks	1/10th Touring Cars/Buggies/ Trucks/Monster Trucks	1/10th SCTs/Truck/ Monster Truck	1/8th Touring Cars/Buggies/ Trucks/Monster Trucks

Connection

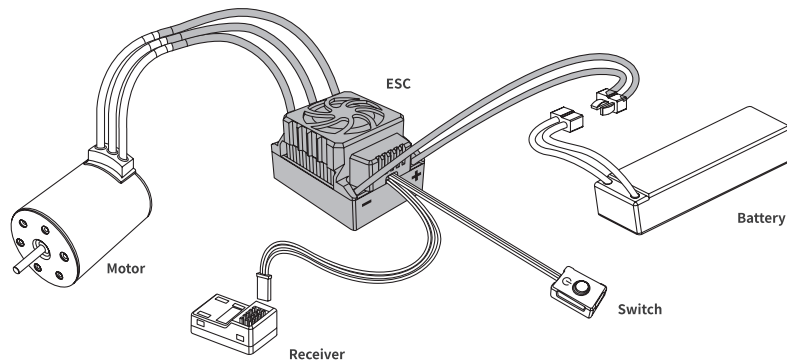

Battery Wire Connection

When connecting the battery, pay attention to polarity: incorrect connection will damage the ESC and Battery. As shown in the figure above, connect the positive (+) wire is connected to (+) battery port, and the negative (-) wire is connected to the (-) battery port.

Motor Wire Connection

The #A, #B, #C wires of the ESC can be connected with the motor wires freely (without any sequence). If the motor runs in the opposite direction, please swap any two wire connections.

Receiver Wire Connection

The signal wire supplies 6.0V to the receiver, servo, etc. So there is no need to connect an additional battery. External power connected to the receiver may damage the ESC.

Black wire	RX-
Red wire	RX+6.0V
White wire	RX-Signal

Software Functions and Settings

Power On/Off ESC

1. Press the power button then the ESC will be powered on.
2. Press and holding the power button until the all LEDs died out, then the ESC will be powered off.
(Note: Please place the throttle trigger on the neutral position: within 10%, otherwise the ESC can not be powered off.)

Throttle Calibration

1. Connect the ESC with the battery and receiver well, then turn on the transmitter.
2. Press and holding the power button until the blue LED is on solid, the motor have a long beep at the same time, then release the power button, the red led will be on solid, the ESC enters to the calibration mode.
3. Pull the throttle trigger to the full throttle position, the blue led blinks three times and the motor beeps once, the full throttle position is saved.
4. Push the throttle trigger to the full brake position, the blue led blinks three times and the motor beeps twice, the full brake position is saved.
5. Release the throttle trigger to the neutral position, the blue led blinks three times and the motor beeps three times, the throttle calibration is completed.
6. The ESC can support reverse throttle calibration, if the transmitter throttle set reverse (it means pull the throttle will go to 1000 throttle position/normally is 2000, and push the throttle will go to 2000 throttle position/normally is 1000), then you do the throttle calibration the same way as usual (as above), it will not have any effects on the ESC forward and reverses way even if the transmitter throttle set reverse.



Please note: No need to restart the ESC again after throttle calibration finished. Do not move the throttle during the time of the blue led blinks.

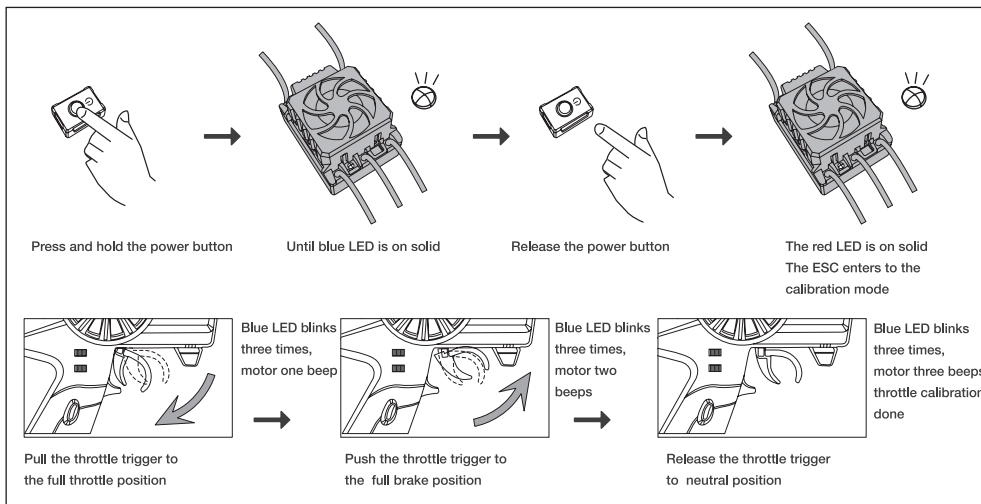

LED Program Card (OPTIONAL)

- How to connect**
Connect the ESC with the battery, power on the ESC, then plug the ESC signal wire into the right socket of the LED, wait for two seconds until LED is on, you are ready to program.
- How to program**
Press MENU button to select the main menu, press VALUE button to select the sub-menu, press OK button to confirm, press RESET button to reset. For example: if you want to set Neutral Range at 8%, press MENU button to select 03, and press VALUE button to select 02, then press OK button.
If you want to reset the ESC value, press the RESET button first, then press OK button.
Check the picture on the right for detail LED programmable value.

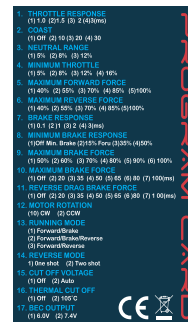

LED Status

1. During operation

Throttle Position	Blue LED	Red LED
Neutral	Blinking	OFF
Full Throttle	ON	ON
Full Brake	OFF	ON

Note: When you pull the throttle from neutral position to full throttle position, the Blue LED will blink, and the blink frequency will go faster when the throttle goes higher.

- When some protection is activated
 - The RED LED is always on solid once the power button is pressed.
 - The RED LED blinks, single flash between every one second. Repeat like "α α α" indicates that the voltage is abnormal.
 - The RED LED blinks, double flash between every one second. Repeat like "αα αα αα" indicates that the temperature is abnormal.
 - The RED LED blinks, single and double flash alternately between every one second. Repeat like "α αα α αα αα" indicates that both of the voltage and temperature is abnormal at the same time. The RED LED will not have any responds even the voltage or temperature is abnormal if not detect the signal.
 - The BLUE LED blinks, double flash between every two seconds. Repeat like "αα αα αα" indicates that the throttle is abnormal. (No throttle, or the throttle is not on the neutral position)

Throttle Signal

- The ESC can support the 450Hz maximum PPM throttle signal.
- The ESC throttle protection will be activated under the following situation, and the BLUE LED blinks double flash:
The throttle trigger do not place on the neutral position when the ESC turns on.
Lost the throttle signal.
- If the ESC lost throttle signal during the operation, the BLUE LED will blink double flash, and the ESC will start to work again until the throttle signal is back to normal.

Sensorless

- The PWM driving frequency will be selected automatically by the ESC on sensorless mode, and the manual setting is invalid.
- It is invalid to set the brake PWM frequency less than 1KHz and forced recognized as 1KHz, if the ESC is on sensorless mode.

Protection

- High Voltage Protection:**
If the ESC detected the voltage too high(Higher than the esc standard voltage), when the ESC turns on, and the voltage protection was not set "OFF", then the voltage protection will be activated, and the maximum throttle output will be limited within 50%.(The high voltage protection only worked on the moment of the ESC turns on, and it will not work on the other stages even it detected the high voltage, once the high voltage protection opened, even though the voltage comes down to the normal voltage, the protection will not be relieved.)
- Low Voltage Protection:**
If the ESC detected the voltage less than the set value at anytime, and this voltage keep for a while, then the low voltage protection is activated, and the maximum throttle output will be limited within 50%.(Once the low voltage protection activated, even though the voltage comes back to normal, the protection can not be relieved.)
- Thermal Protection:**
The output throttle from the ESC will be limited (not over 50%) with the thermal value you have preset.(The Thermal protection will be dismissed when the ESC temperature drop to 65°C)
- If the voltage protection and temperature protection set off, and when the voltage and temperature become abnormal, the LED status will indicates the problems correspondingly but will not limit the throttle output and will not close all ESC timing.
- If the ESC detected the motor have the driving problem (like motor rotor locked or motor phase lost problem) which can cause the motor not run smoothly and when the throttle trigger leave neutral position for a while, then the ESC driving abnormal protection will be activated, and the motor will emit special tone like beep-beep-beep (note: some motors can not beep or beep with a low sound if motor have phase loss problem), and the protection will be closed until you released the throttle trigger to neutral position for 0.2 seconds.
If this problem occurs three times continuously, then you have to solve the motor driving problem first, or the protection will exist all the time.



Programmable Items Description

- Throttle Response:** It indicates how often the ESC performs throttle adjustment.
- Throttle Coast:** When the throttle value changes from high to low, it will decrease every 0.01 second. For example: the current throttle stick is at 80%, and the next moment is at 30%. If the throttle coast is not turned on, the throttle value will be immediately reduced from 80% to 30%. If it is turned on, the throttle value will be 80%, 70%... 30% dropped so slowly.
Note: If the throttle stick is at 0% at the next moment, the throttle value will be equal to 0 immediately. This item only works within the forward throttle range, and has the most obvious effect at 30% throttle.
- Neutral Range:** Throttle midpoint width, the range of the throttle stick in the centered state.
- Min. Throttle:** The minimum throttle, limit the throttle value can not be too small, this item can be adjusted according to the RC car configuration, the smaller the lighter car, this item can be adjusted down, so that the RC car can get a very low speed, the larger the heavier car, this item can be adjusted large, it can eliminate the jitter caused by insufficient starting power.
- Max. Forward force:** If it is set to 80%, the actual throttle value is 80% when the throttle stick is at 100% of the forward throttle.
- Max. Reverse force:** If it is set to 80%, the actual throttle value is 80% when the throttle stick is at the 100% position of the throttle in the reverse direction.
- Brake Response:** It indicates how often the ESC will perform the brake adjustment.
- Min. Brake Force:** It limits the minimum braking force.
- Max. Brake Force:** If the minimum braking force is set larger than the maximum braking force, the maximum braking force is equal to the minimum braking force.
- Fwd. Drag Brake Force:** It refers to the braking force when the throttle stick returns to the 0% position from the forward stroke after the RC car moves forward. If it is turned on, the ESC will turn on correspond brake force when the throttle stick at the 0% position.
- Rev. Drag Brake Force:** Rev drag braking force refers to the braking force when the throttle stick returns to the 0% position from the reverse stroke after the RC car moves backward.
- Motor Rotation:** In some RC cars, under the default rotation, forward and backward are reversed. At this time, setting another motor rotation can correct this error.
- Running Mode:** Running mode includes Forward/Brake, Forward/Brake/Reverse, Forward/Reverse.
- Reverse Mode:** Check the following picture for details.
- Cutoff Voltage:** Check the protection part.
- Thermal Protection:** Check the protection part.

Reverse Mode: One shot & Two shot (In the Forward/Brake/Reverse Mode)

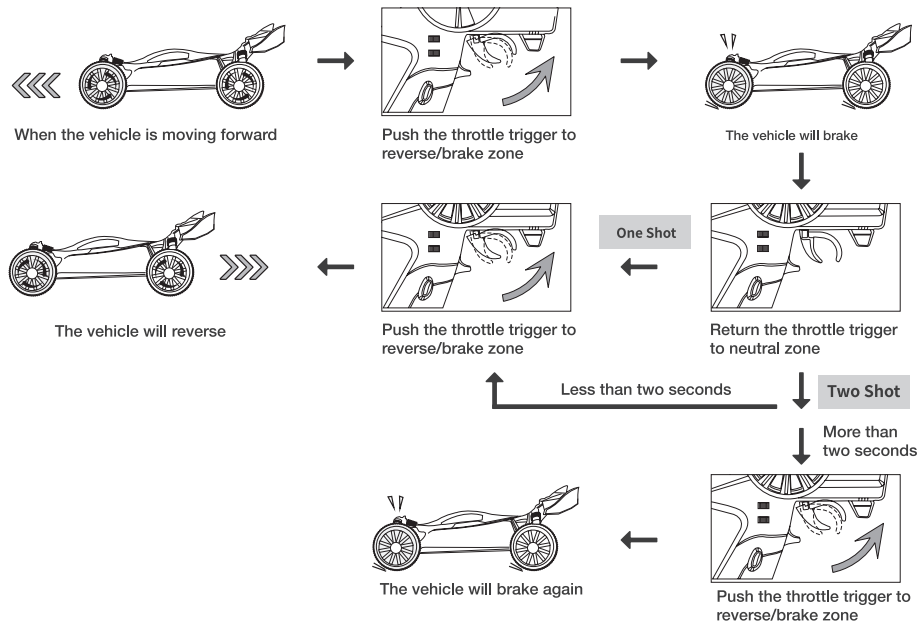

Trouble Shooting

Trouble Shooting	Possible causes	Solutions
The ESC was unable to start the status LED, the motor, and the cooling fan after it was powered on.	<ol style="list-style-type: none"> 1. No power was supplied to the ESC. 2. The ESC switch was damaged. 	<ol style="list-style-type: none"> 1. Check if all ESC & battery connectors have been well soldered or firmly connected. 2. Replace the broken switch.
The motor suddenly stopped or significantly reduced the output in operation.	<ol style="list-style-type: none"> 1. The receiver was influenced by some foreign interference. 2. The ESC entered the battery LVC (Low Voltage Cut off) protection. 3. The ESC entered the thermal (over-heat) protection. 	<ol style="list-style-type: none"> 1. Check all devices and try to find out all possible causes, and check the transmitter's battery voltage. 2. The RED LED blinks, single flash between every one second. 3. The RED LED blinks, double flash between every one second.
The motor stuttered but couldn't start.	<ol style="list-style-type: none"> 1. Some soldering between the motor and the ESC was not good. 2. The ESC was damaged (some MOSFETs were burnt). 	<ol style="list-style-type: none"> 1. Check all soldering points, please re-solder if necessary. 2. Contact the distributor for repair or other customer services.
The car ran forward/backward slowly when the throttle trigger was at the neutral position.	<ol style="list-style-type: none"> 1. The neutral position on the transmitter was not stable, so signals were not stable either. 2. The ESC calibration was not proper. 	<ol style="list-style-type: none"> 1. Replace your transmitter 2. Re-calibrate the throttle range or fine tune the neutral position on the transmitter.



Etronix is a division of CML Distribution Limited, Saxon House, Saxon Business Park, Hanbury Road, Bromsgrove, Worcestershire, B60 4AD.
Email: sales@etronix-rc.com Web: www.etronix-rc.com



GETTING TO KNOW YOUR TRANSMITTER

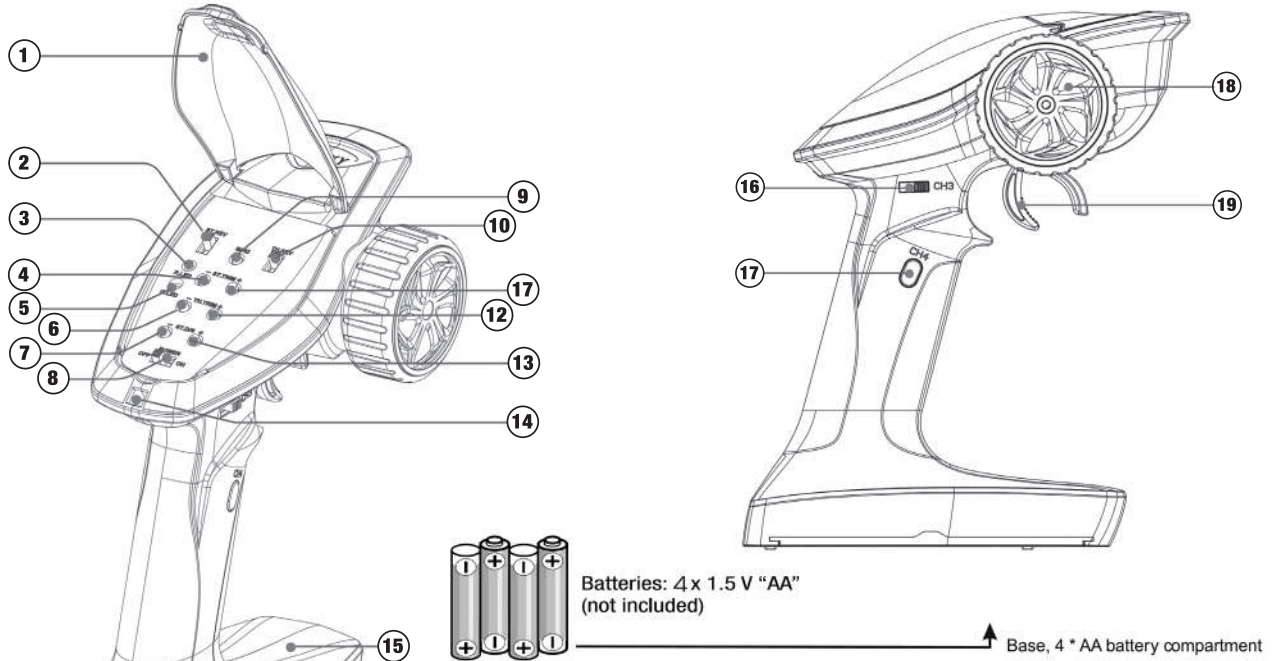

Batteries: 4 x 1.5 V "AA"
(not included)

Base, 4 * AA battery compartment

- | | |
|---|---|
| <ul style="list-style-type: none"> 1 - Cover Panel 2 - Steering Reverse Switch (ST.REV) 3 - Power indicator LED (R. LED) 4 - Steering Trim (ST.TRIM-) 5 - Status indicator green LED (G.LED) 6 - Throttle Trim (TH.TRIM-) 7 - Steering D/R (ST.D / R-) 8 - Power Switch 9 - Bind Button (BIND) 10 - Throttle Reverse (TH.REV) 11 - Steering Trim (ST.TRIM +) | <ul style="list-style-type: none"> 12 - Throttle Trim (TH.TRIM +) 13 - Steering D/R (ST.D / R +) 14 - Lanyard Eye 15 - Base, 4 x AA battery compartment 16 - Three-position switch (CH3) 17 - Button (CH4) 18 - Wheel Angle, the maximum rotation of the steering wheel is 35 degrees from center to left or right (CH1) 19 - Throttle trigger, has a total throw of 12 degrees, 12.5 degrees forward and 12.5 degrees backward (CH2) |
|---|---|

Receiver Overview

To ensure the best signal quality make sure that the receiver is mounted in such a way that the antenna is in the upright, vertical position.

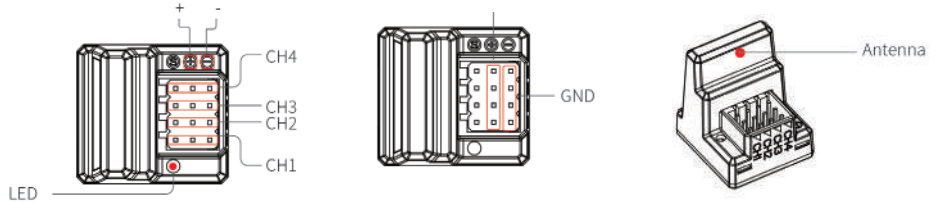

Battery installation

1. Open the battery compartment cover.
2. Insert 4 fully-charged AA batteries into the compartment. Make sure that the battery makes good contact with the battery compartment's contacts and that they are inserted with the correct polarity.
3. Replace battery compartment cover.

NOTE:

The transmitter features a low battery alarm: When the battery is lower than 4.2v, the G.LED on the panel will flash slowly.

Binding

To ensure the best signal quality make sure that the receiver is mounted in such a way that the antenna is in the upright, vertical position.

The transmitter and receiver have already been bound at the factory.

1. Turn on the transmitter while holding the bind button to enter bind mode. G.LED will start flashing quickly. Once in bind mode release the bind button.
2. The receiver will enter bind mode automatically when powered on.
3. Once binding is successful the receiver's LED will flash slowly and the transmitter's LED will remain solid after being rebooted.

NOTE:

When binding, put the transmitter into bind mode first, then the receiver.

Stick Calibration

This function is used to set the neutral position for throttle and steering.

Every transmitter is calibrated before leaving the factory, however if recalibration is required, please follow these steps:

1. Turn and hold the wheel as far clockwise as it will turn, push the throttle trigger all the way forward, then turn on the transmitter in calibration mode.
 - The R.LED and G.LED will flash twice.
2. Calibrate steering: Turn the wheel completely clockwise, then completely counter-clockwise.
 - When calibration is complete the R.LED will turn off.
3. Trigger calibration: Pull the trigger back then forward as far as it will go.
 - When calibration is complete the G.LED will turn off.
4. Once calibration is complete press the bind key to save and exit.



RUNNING YOUR CAR

1. TURNING ON THE RECEIVER OF YOUR CAR

The ESC Receiver switch is located under the bodyshell of the model. Switch on the ESC/Receiver Switch as shown in the picture.



2. TURN ON THE RADIO CONTROLLER

Switch on the power switch on the radio controller. Your radio is bound with your car automatically.



3. CHECK STEERING PERFORMANCE

CENTRE

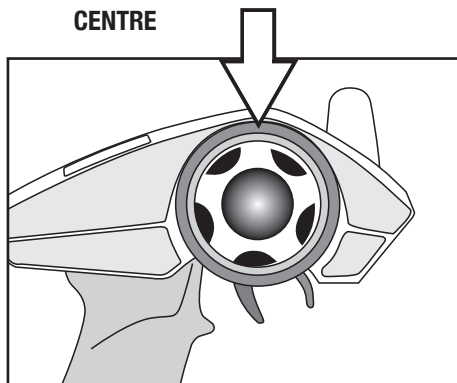

1. To keep the car running straight, keep the steering wheel centered.

TURN RIGHT

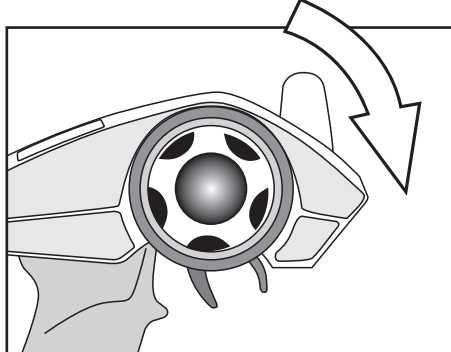

2. Turn the steering wheel to the right to allow the car to right.

TURN LEFT

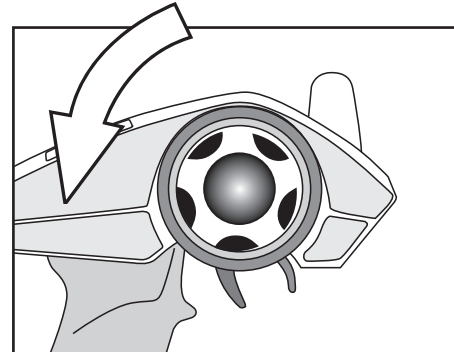

3. Turn the steering wheel to the left to allow the car to turn to the left.

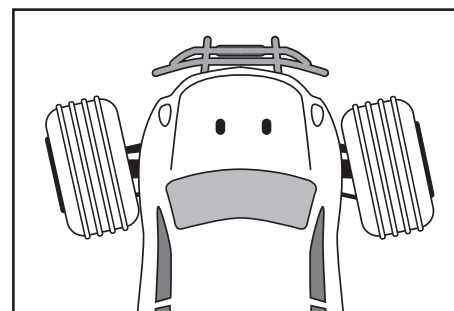
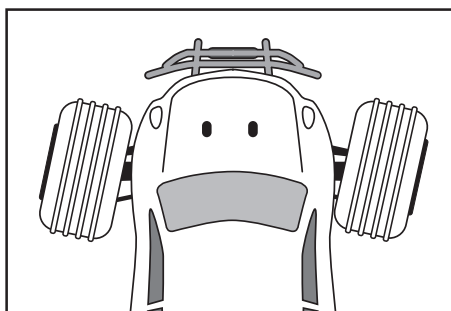
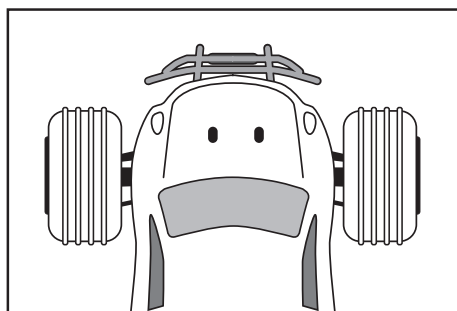

4. CHECK TRIGGER RESPONSE

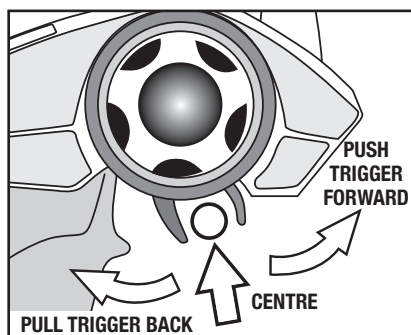

PLEASE NOTE: THE MODEL SWITCHES BETWEEN FORWARD AND REVERSE INSTANTLY FOR SLOW SPEED MANEOUVABILITY. EXCESSIVE USE OF THIS FEATURE CAN CAUSE TRANSMISSION AND ESC DAMAGE.

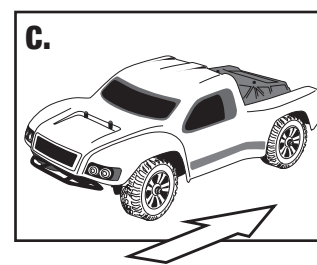
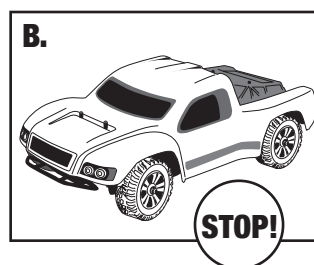
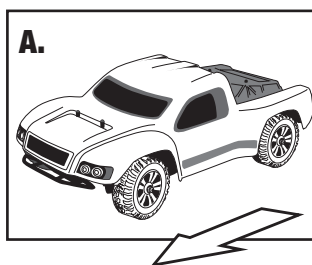

A. Pull the trigger back to accelerate, release it to decelerate.
B. To stop running your car, release the trigger to neutral.
C. Pushing the trigger forward activates reverse.



RUNNING YOUR CAR

5. TUNING THE STEERING TRIM

STEERING TRIM BUTTONS

Gently pull the trigger to allow your car to run slowly. Meantime, tune the steering trim to allow the front wheels to be aligned by pressing the left or right buttons.



STEERING

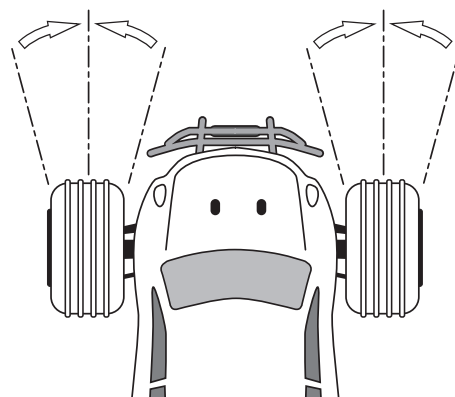

6. TUNING THE THROTTLE TRIM

THROTTLE TRIM BUTTONS

Throttle Trim is used to set the idle speed of the car, by pressing the left or right buttons.



THROTTLE TRIM

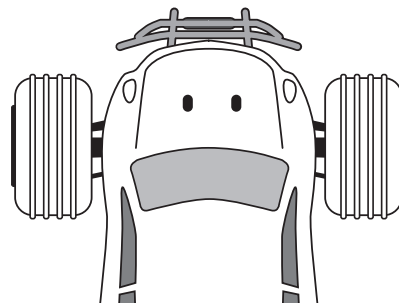

LED INDICATOR:

- When using the trim keys the G.LED will flash slowly for short presses and quickly on long presses.
- When the adjustment value is at the midpoint, the G.LED will flash twice slowly.
- When the adjustment value is at the end of either + or - , the trim adjustment is at its maximum and as such G.LED will not flash.

7. TO TUNE THE STEERING DUAL RATE CONTROL DIAL

STEERING D/R KNOB:

The buttons marked "ST/DR" is for servo travel adjustment. You should adjust this to give maximum steering without straining the servo.

Adjustment range: 0-120%(the default is 100%), the step is 5%.

ST.D / R + : increase servo travel.

ST.D / R - : decrease servo travel.



STEERING D/R

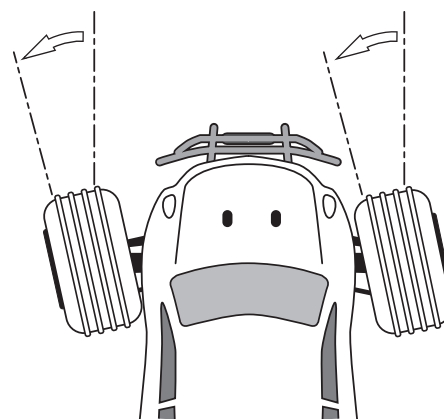

LED INDICATOR:

- When using the trim keys the G.LED will flash slowly on short presses and quickly on long presses.
- When the adjustment reaches the end point the G.LED will no longer flash.

8. STEERING/THROTTLE REVERSE

This function is used to adjust each channels direction of movement in relation to it's input .

The ST.REV/TH.REV switches are the reverse buttons for CH1 and CH2. If the switch is up it indicates reverse, down indicates normal..





PLEASE NOTE:

Although the electronics are waterproof the rest of car can be subjected to damage if running in excessively wet or submerged conditions.

After Run.

Switch off the receiver power, switch off the transmitter and lower the aerial. Disconnect the battery and remove it from the vehicle, allow it to cool before recharging. If you have a second charged battery all ready to use, still allow the vehicle to cool slightly before continuing.

Regular maintenance.

Frequently check the whole vehicle for loose or missing fixings. Use thread lock on any replacement screws into metal threads.

Frequently check rotating parts are free from grass, string etc. that might bind their motion and over stress the motor or speed controller. Remove the wheels occasionally and check behind the mounting hex for obstructions or anything that might have been wrapped around the axle and caused extra drag.

Check the gear mesh frequently and remove any stones or grit from gear teeth to prevent premature wear and damage.

If the motor moves, or is removed for maintenance/exchange, the gear mesh will need to be set. Simply slacken the motor retaining screws and adjust the motor until there is just discernable backlash between pinion and spur teeth. If the gear is too tight or too loose the gears will be noisy and could be damaged.

Shock absorbers will wear prematurely if used in dirty dusty conditions. Replace oil and seals as required to keep a smooth dampening action.

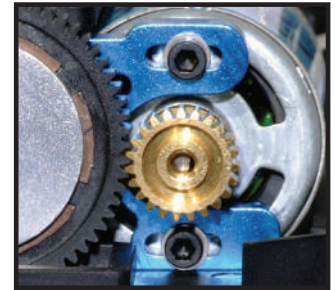

Trouble shooting guide.

<p>Short Runtime: Battery damaged/not charged Motor dirty or brushes worn Drivetrain binding</p>	<p>Sluggish Action: Motor dirty or brushes worn Bind in drive train Battery running low on power</p>	<p>Motor/ESC overheat: Over-gearred Binding transmission. Seized axle bearing. Motor binding</p>	<p>Motor spins but vehicle refuses to move: Gears damaged. Gears loose on shaft. Slipper clutch too loose. Drive shaft broken or missing.</p>	<p>Poor Range or fails to operate: Transmitter batteries low Vehicle Battery Low. Transmitter switched off Transmitter/receiver aerial not extended. ESC switched off or battery not connected. Loose connectors/wires. Water damage. Model electronics are not waterproof.</p>
---	---	---	--	--

Warranty

Due to the nature of this product and potential use FTX warrants it to be free of material and workmanship defects when new. FTX will at its sole discretion repair or replace defective components free of charge within 30 days from date of purchase. This warranty does not cover wear and tear, crash or impact damage, modifications, component water damage failure to perform maintenance or damage from improper use. Proof of purchase date will be required to action any warranty claims. In no case shall FTX's liability exceed the original cost of the purchased kit.

Instructions for disposal.

Environmental Protection Notes & WEEE

The crossed-out wheeled bin symbol shown here, which may be found on the product itself, in the operating instructions or on the packaging, is in accordance with the Waste Electrical and Electronic Equipment (WEEE) Directive. Individual markings indicate which materials can be recycled and re-used. You can make an important contribution to the protection of our common environment by re-using the product, recycling the basic materials or recycling redundant equipment in other ways.

When this product comes to the end of its useful life, you must not dispose of it in the ordinary domestic waste. Many electrical items that we throw away can be repaired or recycled. Recycling items helps to save natural resources and also reduces the environmental and health impacts that are linked with sending electrical goods to landfill. The correct method of disposal is to take it to your local collection point for recycling electrical and electronic equipment. You can go to recycle-more.co.uk for details of locations.

Alternatively FTX can offer our customers free take-back of their WEEE on a like-for-like basis when they buy a new Electrical or Electronic product from us. For example, if a customer bought a new radio system from us or a dealer, we would accept their old radio and prevent it going into a landfill site by disposing of it safely. Customers must return their old WEEE item to us within 28 days of purchasing their new item.

Remove batteries from your device and dispose of them at your local collection point for batteries. If you don't know the location of your nearest disposal centre, please enquire at your local council office.



CML Distribution, Saxon House, Saxon Business Park, Hanbury Road, Bromsgrove, B60 4AD. WEE/GB4215VX





Le FTX Carnage 2.0, 4x4, une voiture de trail à l'échelle 1/10 prête à rouler

Merci d'avoir choisi le FTX Carnage 2.0 4x4 électrique. Ce modèle est monté d'usine, l'électronique est pré installée et réglée pour permettre un démarrage et du plaisir le plus rapidement possible.

Attention: lisez l'intégralité du manuel pour exploiter au mieux la voiture et éviter des dommages mécaniques ou corporels.

Ce modèle n'est pas un jouet, il doit être manipulé avec précaution.

Utilisé dans de mauvaises conditions, ce modèle peut causer des dommages.

Ce modèle n'est pas fait pour être utilisé par un enfant sans la surveillance directe d'un adulte.

Il est essentiel de lire et de suivre les instructions et les recommandations de ce manuel pour entretenir et faire évoluer votre modèle dans de bonnes conditions.



Mesures de sécurité:

- Vous êtes responsable lors de l'évolution de ce modèle, veillez à ne pas vous mettre en danger, à mettre en danger le modèle ou la propriété d'autrui.
- Ce modèle radiocommandé peut être perturbé par d'autres sources d'onde radio, ce qui peut entraîner la perte momentanée du contrôle de la voiture.
- Age recommandé : 14 ans, ceci n'est pas un jouet, ce produit n'est pas fait pour être utilisé par un enfant sans surveillance.

Suivez consciencieusement les instructions suivantes :

- Ne jamais évoluer avec des batteries d'émission faibles
- Toujours évoluer dans une zone dégagée, loin de la circulation et de la foule
- Ne jamais évoluer dans une rue ou un endroit fréquenté
- Toujours garder le modèle dans son champ de vision
- Gardez hors de portée des enfants tous les composants de petite taille, électriques ou chimiques
- Tenez le modèle hors de portée de l'eau (la rouille peut causer des dommages irréversibles au modèle)
- Faites attention aux pièces en rotations, axes, pignons etc.
- Les débutants doivent prendre conseil auprès de personnes plus expérimentées
- Faites attention lors de l'utilisation des outils
- Attention à ne pas mettre les doigts ou d'autres parties du corps en contact avec les pièces en rotation
- Faites attention lors du transport, de la maintenance ou de la réparation, certaines pièces peuvent être coupantes.
- NE JAMAIS toucher les composants tels que le moteur, le variateur ou les batteries après utilisation, ces pièces peuvent être chaudes
- Lorsque vous changez de fréquence d'émission assurez-vous que les quartz de fréquence sont bien positionnés (RX pour récepteur et TX pour l'émetteur)
- Toujours éteindre en premier la voiture avant l'émetteur
- Vérifiez le bon fonctionnement de la voiture les roues dans le vide (en prenant les précautions nécessaires)
- Prolongez la durée de vie du moteur en le préservant de la surchauffe (la durée de vie du moteur dépend aussi de la fréquence de roulage, des changements rapide de direction avant/arrière, des conditions de roulage difficiles poussière/boue des utilisations abusives tirer/pousser des objets)

Contents:

- 1 FTX Carnage 2.0 1/10ème prêt à rouler électrique
- 1 Emetteur à volant fréquence 2.4GHz
- 1 Chargeur: entré 240V sortie 800mA
- 1 Batterie: 3250mAh 7.4V 2S LiPo
- 1 Voltz Lipo Sac de charge de sécurité



EQUIPMENTS REQUIS POUR LA MAINTENANCE:

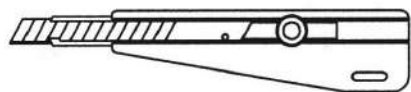

● Cutter



● Règle

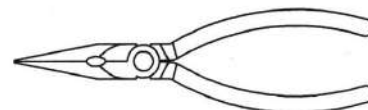

● Pince

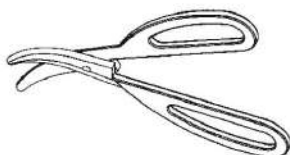

● Ciseaux à lexan

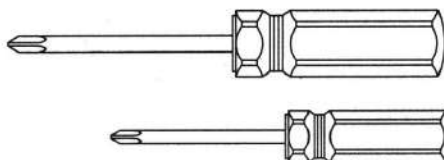

● Tournevis plats et cruciformes

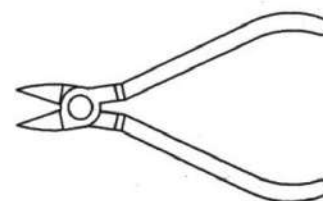

● Pince coupante

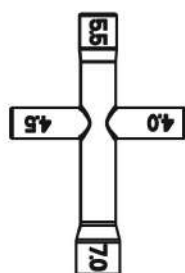

● Clé

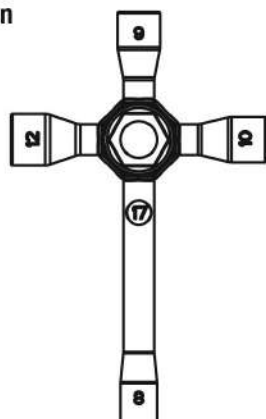

● Colle à pneu



● Frein filet

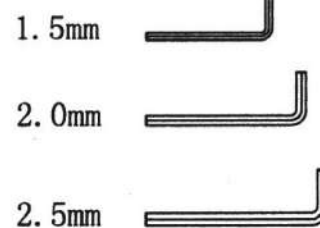

● Clé Allen

ATTENTION: L'utilisation d'une visseuse électrique pour la maintenance pourrait endommager l'emprunte des vis ou casser des pièces du modèle.

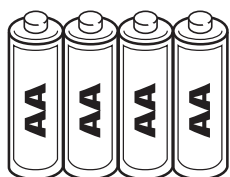

4 piles alcalines AA pour l'émetteur

IMPORTANT: Veuillez vérifier le serrage de chaque vis et écrous avant l'utilisation du modèle.

CHARGER/INSTALLER LA BATTERIE

IMPORTANT ! TOUJOURS CHARGER LES ACCUS LIPO A L'AIDE D'UN SAC DE CHARGE DE PROTECTION ADAPTE ET LE PLUS ELOIGNE POSSIBLE DES MATIERES INFLAMMABLES. NE JAMAIS CHARGER LES ACCUS SANS SURVEILLANCE ET TOUJOURS STOCKER LA VOITURE SANS LA BATTERIE A L'INTERIEUR.

Toujours débrancher et enlever la batterie lors du stockage de votre modèle. Ne jamais charger une batterie directement sur le modèle. Le chargeur/équilibreur LIPO mural 900 mAh fourni avec la voiture prend approximativement 2.5h pour recharger une batterie complètement déchargée. Avant de mettre en charge vérifiez que la batterie est bien placée dans le sac de charge Valt. (Les batteries LIPO peuvent être dangereuses, elles doivent être manipulées avec précaution.) Les Batteries LIPO requièrent une charge totalement différente que des batteries NIMH, assurez vous de bien connaître la procédure avant de commencer la charge. Une erreur peut provoquer le feu ou des blessures. L'utilisateur doit assumer les conséquences et les risques de l'utilisation des batteries LIPO. (Retournez immédiatement le produit non utilisé si vous n'acceptez pas ces risq).

ATTENTION! NE LAISSEZ JAMAIS UNE BATTERIE CHARGER SANS SURVEILLANCE.

- Le chargeur fourni peut charger des Batteries 2S ou 3S (nombres d'éléments). Les batteries fournies sont des batteries 2S assurez vous de connecter correctement l'équilibreur. La LED rouge indique le nombre d'éléments chargés (2 va être éclairé) et la LED va passer au vert lorsque la charge est complète. Si toutes les LED se mettent à clignoter ensemble, arrêtez la charge, déconnectez l'accu puis recommencez la charge. Quand la charge est terminée, déconnectez la batterie (le chargeur peut être chaud). Toujours débrancher le chargeur de la prise murale mais aussi la batterie du chargeur lors de la non-utilisation.
- Tenez les enfants loin du chargeur et de la batterie lors de la charge.
- Pour installer une batterie de votre voiture, retirez les clips de carrosserie et la carrosserie.
- Desserrer les sangles, insérer la batterie, puis serrer les sangles de manière à ce qu'elles maintiennent fermement la batterie à l'intérieur du boîtier de batterie.

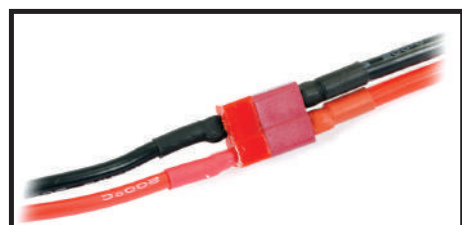
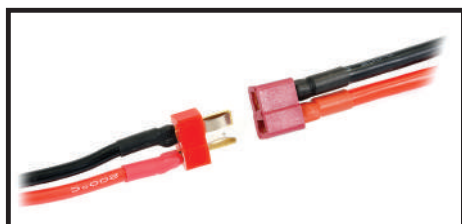

- Assurez-vous que l'interrupteur de la voiture est sur la position off avant de connecter la batterie.

UTILISATION DE LA BATTERIE:

- Toujours refroidir une batterie après son utilisation
- Toujours inspecter une batterie avant de la charger (Tout fil dénudé, fissure dans la gaine thermo-rétractable ou fuite est un signe de mauvaise utilisation de la batterie)
- Ne jamais essayer de charger une batterie présentant des signes de faiblesse.
- Ne jamais démonter une batterie ou couper les fils de connexion.
- Si les fils de connexion deviennent très chauds, c'est qu'il y a probablement un problème avec votre modèle, variateur de vitesse ou moteur. Trouvez et corrigez le problème avant de remplacer la batterie et de réessayez. Ne jamais charger la batterie sans surveillance.
- Toujours charger loin de produits inflammables et sur une surface non inflammable (en cas où la batterie deviendrait très chaude).
- S'IL VOUS PLAÎT SE REFERER A LA MANIPULATION DETAILLEE DES BATTERIES LIPO**

BATTERIE LIPO – CONSIGNES DE SECURITE ET DE MANUTENTION POUR L'UTILISATEUR.

- Lire toutes les consignes de sécurité avant de charger ou d'utiliser vos batteries la première fois.
- Les batteries LiPo requiert une charge et une attention totalement différente des batteries NiCd ou NiMH. Une utilisation abusive peut provoquer un incendie, des blessures et/ou des dommages à la propriété. L'acheteur assume toute la responsabilité et le risqué associé à l'utilisation de batteries Lithium-Polymer (LiPo). Retourner immédiatement la batterie non utilisée si vous n'êtes pas d'accord avec ces termes.

Directives et avertissements généraux:

- Utiliser un chargeur spécifique pour Lithium Polymer ! Ne pas utiliser un chargeur pour NiCd ou NiMH.
- Ne JAMAIS charger sans attention. Toujours charger dans un sac de charge ou une boîte en métal avec un couvercle et loin de matériaux inflammables.
- Durant le processus de charge surveiller que les cellules ne gonflent pas et ne sont pas ballonnées. Si cela arrive déconnecter immédiatement le chargeur et placer les batteries dans un lieu ignifugé pendant 15 minutes. **NE PAS TENTER DE RECHARGER CES BATTERIES.**
- Un court-circuit peut causer une décharge rapide avec de forts courants. Eviter les court-circuits, et soyez conscients que vos bijoux peuvent en provoquer.
- Toute batterie Lithium Polymer impliquée dans un accident doit être retirée et observée dans un espace ignifugé pendant 15 minutes avant de continuer à l'utiliser ou la charger.
- Si vous re-câblez la batterie, re-câbler les fils un à la fois. Ne pas couper les deux fils. Ne pas court-circuiter sur vos outils.
- Ne pas exposer vos batteries pendant de longues périodes au soleil.
- Ne pas tenter d'altérer ou d'ouvrir le boîtier LiPo. La coque est une protection contre les gonflements possibles de la batterie.

Avant la charge:

Inspecter visuellement la batterie, fils, connecteurs, si la gaine thermo rétractable n'est pas endommagée, un gonflement ou tout autre dommage. Ne pas charger le pack s'il est endommagé.

Processus de charge:

- NE JAMAIS charger sans attention.
- Charger en dehors d'en endroit contenant des matériaux inflammables et dans un sac LiPo ou une boîte en métal avec un couvercle.
- Laisser refroidir le pack avant de le charger.
- Utiliser l'étiquette de la batterie pour régler la tension et le nombre de cellule sur le chargeur.
- NE pas charger à plus de 5C. (Exemple, charger un pack de 1000mAh à 5A MAX)

En cas d'élimination d'une batterie procéder comme suit: Immerger la batterie dans un container remplis avec environ 10litres d'eau salée (une tasse de sel pour 10L). Laisser la batterie immerger pendant 2 semaines, cela permettra de décharger la batterie lentement et sûrement jusqu'à ce que le voltage soit à zéro ce qui permettra d'éliminer tout risqué de réaction chimique. Il peut ensuite être déposé dans un bac de recyclage.



Remarque : Il n'est pas nécessaire de redémarrer l'ESC une fois la calibration de l'accélérateur terminée. Ne pas bouger l'accélérateur pendant le temps où la led bleue clignote.

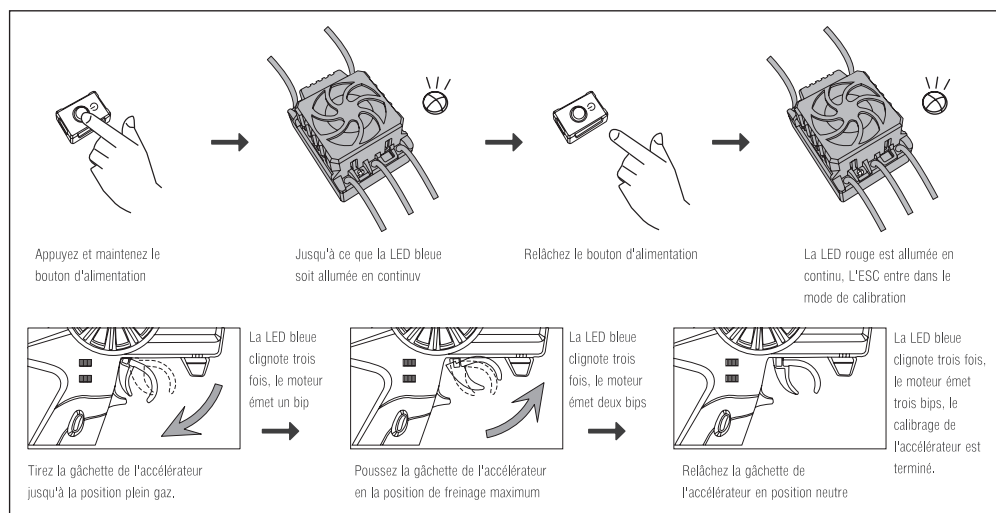

Carte de programme LED (Optionnelle)

- Comment connecter. Connectez l'ESC à la batterie, allumez l'ESC, puis branchez le fil de signal de l'ESC dans la prise droite de la LED dans la prise droite de la LED, attendez deux secondes que la LED s'allume, vous êtes prêt à programmer, prêt à programmer.
- Comment programmer Appuyez sur le bouton MENU pour sélectionner le menu principal, appuyez sur le bouton VALUE pour sélectionner le sous-menu, appuyez sur la touche VALUE pour sélectionner le sous-menu, appuyez sur la touche OK pour confirmer, appuyez sur la touche RESET pour réinitialiser. Par exemple : si vous souhaitez régler la plage neutre à 8%, appuyez sur le bouton MENU pour sélectionner 03, et appuyez sur la touche VALUE pour sélectionner 02, puis appuyez sur la touche OK. Si vous voulez réinitialiser la valeur ESC, appuyez d'abord sur le bouton RESET, puis sur le bouton OK. Consultez l'image de droite pour le détail des valeurs programmables des LED.

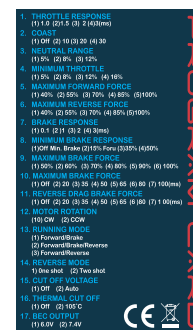
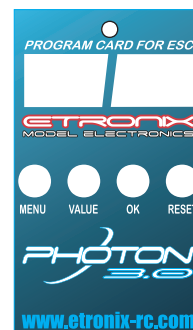

État des LED

1. pendant le fonctionnement

Position du papillon des gaz	LED bleue	LED rouge
Neutre	Clignotant	OFF
Plein gaz	ON	ON
Frein à fond	OFF	ON

Remarque : Lorsque vous tirez sur l'accélérateur de la position neutre à la position plein gaz, la DEL bleue clignote, et la fréquence de clignotement s'accroît lorsque l'accélérateur est plus élevé.

- Lorsqu'une protection est activée2. Lorsqu'une protection est activée
 - La LED ROUGE est toujours allumée en continu une fois que vous appuyez sur le bouton d'alimentation.
 - Le voyant ROUGE clignote, en un seul éclair toutes les secondes. Répéter comme "α α α" indique que la tension est anormale.
 - Le voyant ROUGE clignote, avec un double clignotement toutes les secondes. Répéter comme "αα αα αα" indique que la température est anormale.
 - Le voyant ROUGE clignote, avec un et deux clignotements alternés toutes les secondes. Répéter comme "α α αα αα αα" indique que la tension et la température sont anormales en même temps.
 - La LED ROUGE ne répondra pas même si la tension ou la température est anormale si elle ne détecte pas le signal.
 - La LED BLEUE clignote, doublement toutes les deux secondes. Répéter comme "αα αα αα" indique que l'accélérateur est anormal. (Pas d'accélérateur, ou l'accélérateur n'est pas en position neutre).

Signal de l'accélérateur

- L'ESC peut supporter le signal d'accélérateur PPM 450Hz maximum.
- La protection de l'accélérateur de l'ESC sera activée dans la situation suivante, et la LED BLEUE clignote deux fois :
 - La gâchette de l'accélérateur ne se place pas en position neutre lorsque l'ESC s'allume.
 - Perte du signal de l'accélérateur.
- Si l'ESC perd le signal de l'accélérateur pendant le fonctionnement, la LED BLEUE clignote deux fois, et l'ESC recommence à fonctionner jusqu'à ce que le signal de l'accélérateur soit revenu à la normale.

Sans capteur

- La fréquence de commande PWM sera sélectionnée automatiquement par l'ESC en mode sans capteur, et le réglage manuel n'est pas valide.
- Il n'est pas possible de régler la fréquence PWM du frein inférieure à 1KHz et reconnue comme 1KHZ, si l'ESC est en mode sensorless.

Protection

- Protection contre la haute tension : Si l'ESC détecte une tension trop élevée (supérieure à la tension standard de l'esc), lorsque l'ESC s'allume, et que la protection de la tension n'est pas réglée sur "OFF", alors la protection de la tension sera activée, et la sortie maximale de l'accélérateur sera limitée à 50%. (La protection de la haute tension ne fonctionne qu'au moment où l'ESC s'allume, et elle ne fonctionnera pas sur les autres étapes même si elle a détecté la haute tension, une fois la protection de la haute tension ouverte, même si la tension redescend à la tension normale, la protection ne sera pas levée).
- Protection contre la basse tension : Si l'ESC détecte une tension inférieure à la valeur définie à tout moment, et que cette tension se maintient pendant un certain temps, la protection contre la basse tension est activée, et la sortie maximale de l'accélérateur sera limitée. (Une fois la protection contre la basse tension activée, même si la tension revient à la normale, la protection ne peut être levée), protection ne peut être levée).
- Protection thermique : La sortie de l'accélérateur de l'ESC sera limitée (pas plus de 50%) avec la valeur thermique que vous avez pré-réglée. (La protection thermique sera annulée lorsque La température de l'ESC tombe à 65°C, température de l'ESC descend à 65°C)
- Si la protection de la tension et la protection de la température sont désactivées, et lorsque la tension et la température deviennent anormales, l'état de la LED indiquera les problèmes correspondants, mais ne limitera pas la protection. problèmes correspondants, mais ne limitera pas la sortie de l'accélérateur et ne fermera pas toutes les temporisations de l'ESC.
- Si l'ESC détecte que le moteur a un problème de conduite (comme le rotor du moteur bloqué ou un problème de perte de phase du moteur), ce qui peut empêcher le moteur de fonctionner correctement, et que la gâchette de l'accélérateur quitte la position neutre pendant un certain temps, la protection contre les anomalies de conduite de l'ESC sera activée, et le moteur émettra un signal sonore spécial du type bip-bip-bip, spécial comme un bip-bip-bip (note : certains moteurs ne peuvent pas émettre de bip ou émettent un bip de faible intensité si le moteur a un problème de perte de phase), jusqu'à ce que vous relâchiez la gâchette de l'accélérateur en position neutre pendant 0,2 seconde. Si ce problème se produit trois fois de manière continue, vous devez d'abord résoudre le problème de conduite du moteur, sinon la protection se fermera, moteur d'abord, sinon la protection sera toujours présente.

Éléments programmables Description

1. Throttle Response: Il indique la fréquence à laquelle l'ESC effectue le réglage de l'accélérateur.
2. Throttle Coast: Lorsque la valeur de la manette des gaz passe de haut en bas, elle diminue toutes les 0,01 seconde. Par exemple : la manette des gaz actuelle est à 80%, et le moment suivant est à 30%. Si la fonction d'accélération n'est pas activée, la valeur de l'accélérateur sera immédiatement réduite de 80% à 30%. Si elle est activée, la valeur de l'accélérateur sera de 80%, 70%... 30 %, puis diminuera lentement. Remarque : si la manette des gaz est à 0 % au moment suivant, la valeur des gaz sera immédiatement égale à 0. Cet élément ne fonctionne que dans la plage de l'accélérateur avant, et a l'effet le plus évident à 30% de l'accélérateur.
3. Neutral Range: Largeur du point médian de la manette des gaz, la plage de la manette des gaz dans l'état centré.
4. Min. Throttle: L'accélérateur minimum, limite la valeur de l'accélérateur ne peut pas être trop petite, cet élément peut être ajusté selon la configuration de la voiture RC, le plus petit la voiture plus légère, cet élément peut être ajusté vers le bas, de sorte que la voiture RC peut obtenir une très faible vitesse, la plus grande la voiture plus lourde, cet élément peut être ajusté grande, il peut éliminer l'instabilité causée par une puissance de démarrage insuffisante.
5. Max. Forward force: S'il est réglé sur 80%, la valeur réelle de l'accélérateur est de 80% lorsque la manette des gaz est à 100% de l'accélérateur avant.
6. Max. Reverse force: S'il est réglé sur 80 %, la valeur réelle de l'accélérateur est de 80 % lorsque la manette des gaz est à la position 100 % de l'accélérateur dans le sens inverse.
7. Brake Response: Il indique la fréquence à laquelle l'ESC effectuera le réglage des freins.
8. Min. Brake Force: Il limite la force de freinage minimale.
9. Max. Brake Force: Si la force de freinage minimale est supérieure à la force de freinage maximale, la force de freinage maximale est égale à la force de freinage minimale, minimale.
10. Fwd. Drag Brake Force: Il s'agit de la force de freinage lorsque la manette des gaz revient à la position 0 % après la course avant, une fois que la voiture RC a avancé, en avant. S'il est activé, l'ESC activera la force de freinage correspondante lorsque la manette des gaz est en position 0 %.
11. Rev. Drag Brake Force: La force de freinage en marche arrière fait référence à la force de freinage lorsque la manette des gaz revient à la position 0 % de la marche arrière après que la voiture RC ait reculé, voiture RC se déplace en arrière.
12. Motor Rotation: Dans certaines voitures RC, avec la rotation par défaut, la marche avant et la marche arrière sont inversées. À ce moment-là, le réglage d'une autre rotation du moteur peut corriger cette erreur.
13. Running Mode: Le mode de fonctionnement comprend la marche avant/frein, la marche avant/frein/marche arrière, la marche avant/marche arrière.
14. Reverse Mode: Consultez l'image suivante pour plus de détails.
15. Cutoff Voltage: Vérifiez la partie protection.
16. Thermal Protection: Vérifiez la partie protection.

• Mode inversé : Un coup et deux coups (En mode avant/frein/arrière)

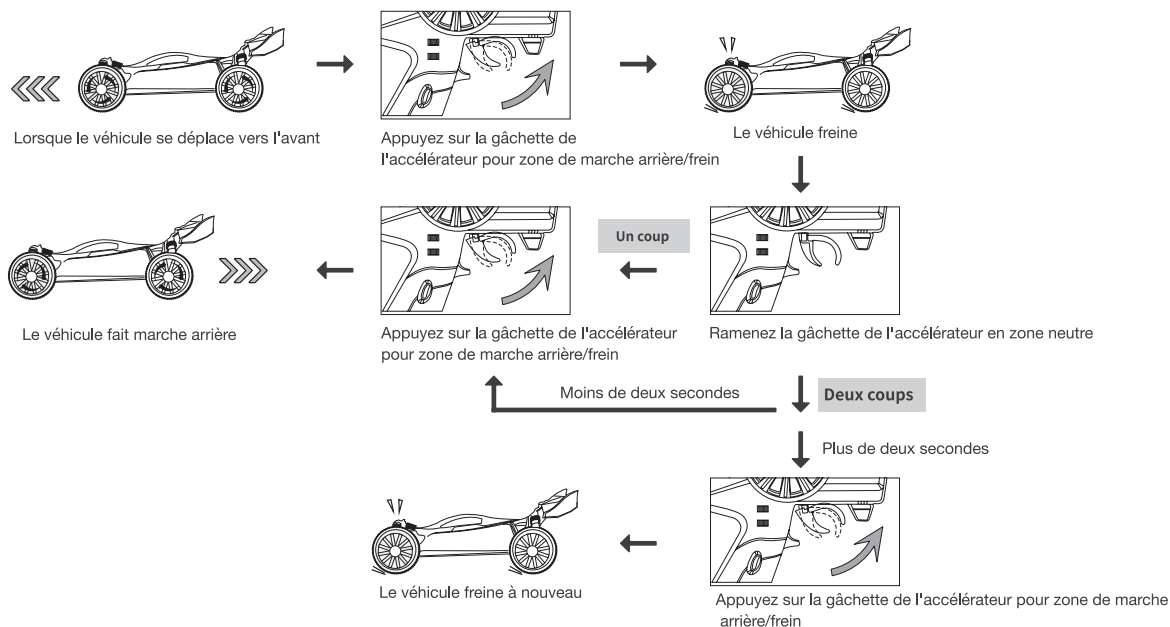

Dépannage

Dépannage	Causes possibles	Solutions
L'ESC n'a pas pu démarrer la LED d'état, le moteur, et le ventilateur de refroidissement après qu'il ait été sous tension.	<ol style="list-style-type: none"> 1. Aucune alimentation n'a été fournie à l'ESC. 2. L'interrupteur de l'ESC était endommagé. 	<ol style="list-style-type: none"> 1. Vérifiez si tous les connecteurs de l'ESC et de la batterie ont été bien soudés ou fermement connectés. 2. Remplacez l'interrupteur cassé.
Le moteur s'est soudainement arrêté ou a considérablement réduit la puissance en fonctionnement.	<ol style="list-style-type: none"> 1. Le récepteur a été influencé par des interférences étrangère. 2. L'ESC est entré dans la protection LVC (Low Voltage Cut off) de la batterie, de la batterie (Low Voltage Cut off). 3. L'ESC est entré dans la protection thermique (surchauffe) thermique (surchauffe). 	<ol style="list-style-type: none"> 1. Vérifiez tous les appareils et essayez de trouver toutes les causes possibles, causes possibles, et vérifiez la tension de la batterie de l'émetteur de l'émetteur. 2. La LED ROUGE clignote, avec un seul flash toutes les secondes, seconde. 3. La LED ROUGE clignote, en double clignotement toutes les secondes, seconde.
Le moteur bégayait mais ne pouvait pas démarrer.	<ol style="list-style-type: none"> 1. Certaines soudures entre le moteur et le contrôleur électronique n'étaient pas bonne. 2. L'ESC était endommagé (certains MOSFETs étaient brûlés). 	<ol style="list-style-type: none"> 1. Vérifiez tous les points de soudure, ressoudez si nécessaire, si nécessaire. 2. Contactez le distributeur pour une réparation ou d'autres services à la clientèle.
La voiture avançait ou reculait lentement lorsque la gâchette de l'accélérateur était au neutre position neutre.	<ol style="list-style-type: none"> 1. La position neutre de l'émetteur n'était pas stable, donc les signaux n'étaient pas stables non plus. 2. La calibration de l'ESC n'était pas correcte. 	<ol style="list-style-type: none"> 1. Remplacez votre émetteur 2. Recalibrez la plage des gaz ou ajustez la position neutre de l'émetteur, position neutre de l'émetteur.

ETRONIX
MODEL ELECTRONICS

Etronix is a division of CML Distribution Limited.
Saxon House, Saxon Business Park, Hanbury Road, Bromsgrove, Worcestershire, B60 4AD.
Email: sales@etronix-rc.com Web: www.etronix-rc.com

DÉCOUVERTE DE VOTRE TÉLÉCOMMANDE

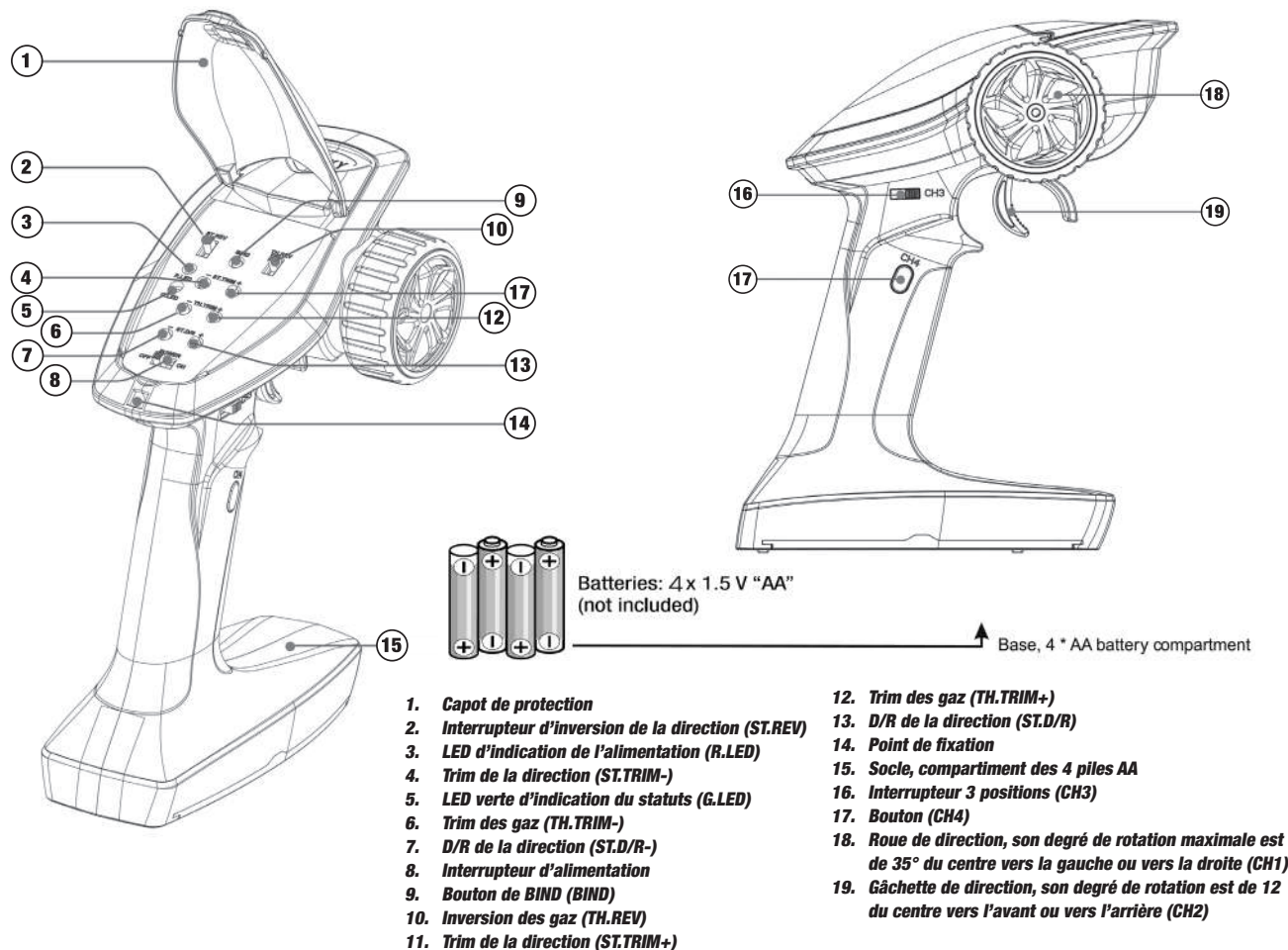

1. Capot de protection
2. Interrupteur d'inversion de la direction (ST.REV)
3. LED d'indication de l'alimentation (R.LED)
4. Trim de la direction (ST.TRIM-)
5. LED verte d'indication du statuts (G.LED)
6. Trim des gaz (TH.TRIM-)
7. D/R de la direction (ST.D/R-)
8. Interrupteur d'alimentation
9. Bouton de BIND (BIND)
10. Inversion des gaz (TH.REV)
11. Trim de la direction (ST.TRIM+)
12. Trim des gaz (TH.TRIM+)
13. D/R de la direction (ST.D/R)
14. Point de fixation
15. Socle, compartiment des 4 piles AA
16. Interrupteur 3 positions (CH3)
17. Bouton (CH4)
18. Roue de direction, son degré de rotation maximale est de 35° du centre vers la gauche ou vers la droite (CH1)
19. Gâchette de direction, son degré de rotation est de 12 du centre vers l'avant ou vers l'arrière (CH2)

Vue générale du récepteur

Afin d'assurer le meilleur signal possible, positionnez le récepteur de manière à ce que l'antenne soit positionnée vers le haut.

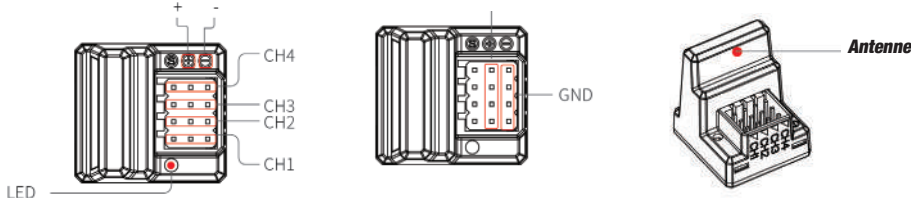

Installation des piles

1. Ouvrez le couvercle du compartiment des piles
2. Insérez 4 piles AA entièrement chargées dans le compartiment tout en vérifiant bien les polarités et leur bon montage.
3. Remettez en place le couvercle

NOTE :

La télécommande possède une alarme en cas de faible tension : Lorsque les piles sont en dessous de 4.2V, la G.LEC sur tableau de bord va clignoter lentement.

Liaison du récepteur et de la télécommande (BIND)

Afin d'assurer le meilleur signal possible, positionnez le récepteur de manière à ce que l'antenne soit positionnée vers le haut.

La télécommande et le récepteur ont déjà été reliés en usine.

1. Allumez la télécommande tout en maintenant le bouton BIND pour entrer dans le mode bind. La G.LED va clignoter rapidement. Une fois dans le mode bind, vous pouvez relâcher le bouton de bind.
2. Le récepteur va automatiquement rentrer en mode bind lorsque vous allez l'allumer.
3. Lorsque la liaison est effectuée, la LED du récepteur va clignoter lentement et la LED de la télécommande va rester allumer une fois redémarrée.

NOTE:

Lors de la liaison, mettez d'abord la télécommande en mode bind puis le récepteur.

Calibration des commandes

Cette fonction permet de déterminer la position neutre de la gâchette des gaz et du volant de direction.

Chaque télécommande est calibrée avant de partir de l'usine, cependant si vous avez besoin de la recalibrer, voici les étapes à suivre :

1. Tournez au max le volant dans le sens des aiguilles d'une montre, poussez au max la gâchette des gaz vers l'avant et allumez la télécommande pour entrer dans le mode de calibration. Les LED R.LED et G.LED vont flasher 2 fois.
2. Calibration de la direction : Tournez au max le volant dans le sens des aiguilles d'une montre puis à fond dans le sens inverse aux aiguilles d'une montre. Lorsque cette calibration est terminée, la R.LED va s'éteindre.
3. Calibration des gaz : Tirez au max la gâchette des gaz vers l'arrière puis à fond vers l'avant. Lorsque cette calibration est terminée, la G.LED va s'éteindre.
4. Une fois la calibration effectuée, appuyez sur le bouton de bind pour sauvegarder et quitter.

GESTION DE VOTRE VOITURE

1. METTRE SUR ON INTERRUPTEUR

L'ensemble variateur/ récepteur se situe sur ON comme montré sur la photo.



2. METTRE LA RADIO SUR ON

Mette le bouton d'allumage de la radio sur ON. Votre voiture est automatiquement appairer avec votre radio.



3. ASSURE UNE BONNE PERFORMANCE DE PILOTAGE

CENTRE

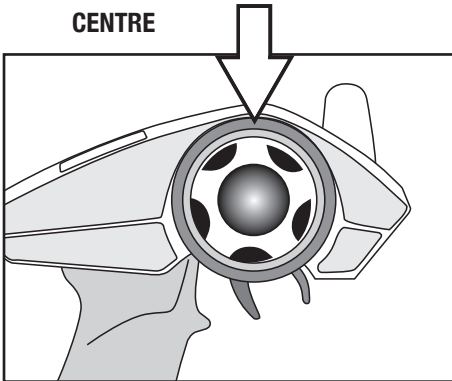

1. Pour que la voiture aille droite ne pas tourner le volant (le laisser au centre).

TOURNE À DROITE

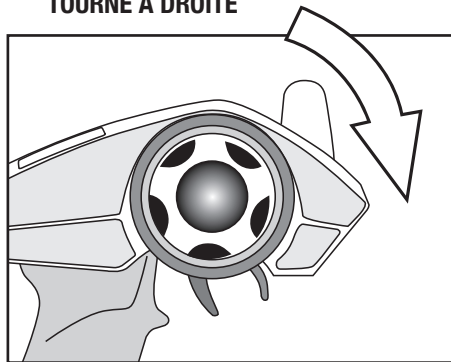

2. Tourner à droite pour permettre à votre d'aller à gauche.

TOURNE À GAUCHE

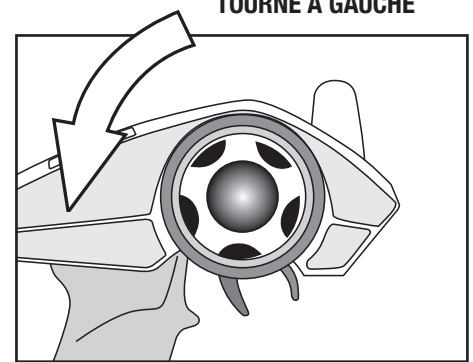

3. Tourner à gauche pour permettre à votre voiture d'aller à droite.

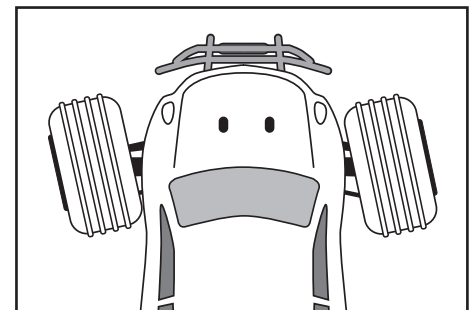
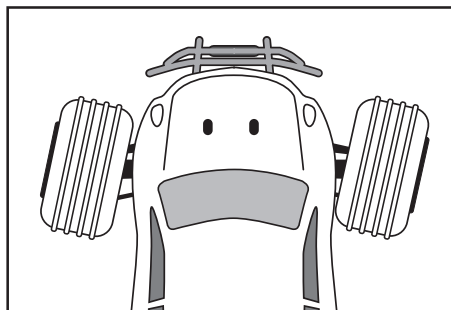
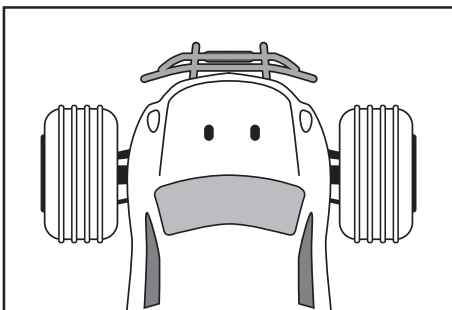

4. VÉRIFIER LA REEONSE DE LA GACHETTE

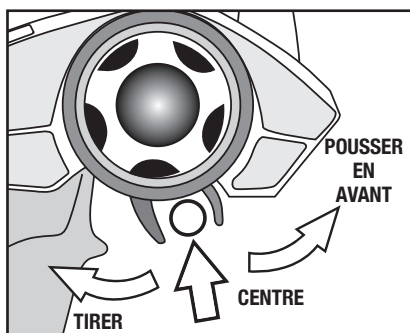

S'IL VOUS PLAÎT NOTEZ :
LE MODÈLE PASSE ENTRE LA MARCHÉ AVANT ET ARRIÈRE INSTANTANÉMENT POUR UNE MANŒVRABILITÉ À FAIBLE VITESSE. UNE UTILISATION EXCESSIVE DE CETTE FONCTIONNALITÉ PEUT ET VA ENDOMMAGER LA TRANSMISSION ET L'ESC.

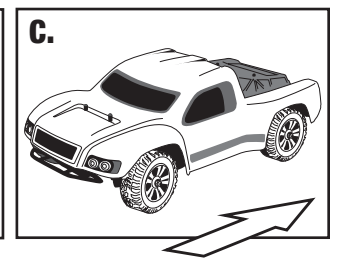
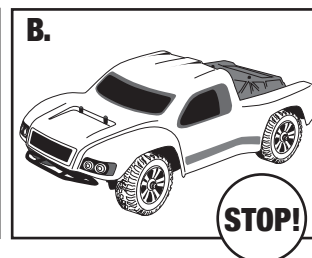
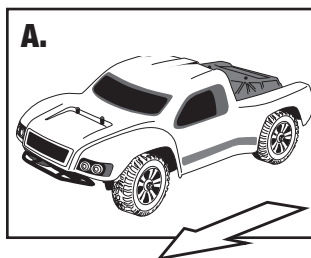

A. Tirer la gâchette en arrière pour accélérer? La lâcher pour décélérer et la pousser pour freiner.

B. Pour arrêter la voiture, lâchette jusqu'au neutre.

C. Pousser la gâchette vers l'avant active la marche arrière.

GESTION DE VOTRE VOITURE

5. RÉGLAGE DU TRIM DE DIRECTION

Accélérez tout doucement afin de faire lentement avancer la voiture. Appuyez-en même sur les boutons droit et gauche pour régler l'orientation des roues afin que la voiture avance tout droit.



STEERING

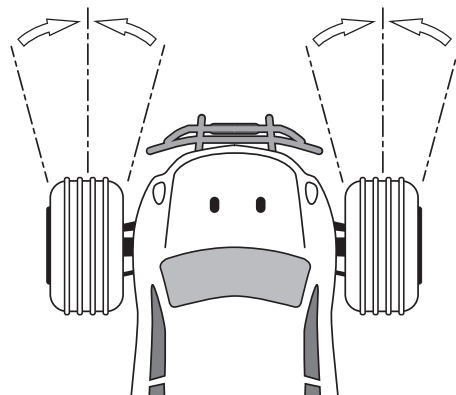

6. RÉGLAGE DU TRIM D'ACCÉLÉRATION

Le bouton de trim d'accélérateur est utilisé pour régler le régime de ralenti de la voiture.

INDICATEUR LED:

- Lorsque vous utilisez les boutons de réglage du trim, la LED clignote lentement pour un appui court et rapidement pour un appui long.
- Quand la valeur du trim est au milieu, la LED clignote 2 fois lentement
- Quand la valeur du trim est au maximum vers la droite ou vers la gauche, la LED ne clignote pas



THROTTLE TRIM

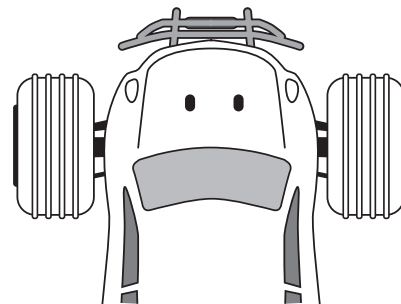

7. RÉGLAGE DES BUTÉES DE DIRECTION

Le bouton noté « ST/DR » est utilisé pour régler les fins de course du servo de direction

Ajustable de 0 à 120% (100% par défaut), une pression du bouton change la valeur de 5%

ST.D / R + : Augmente la course de direction

ST.D / R - : Réduit la course de direction



STEERING D/R

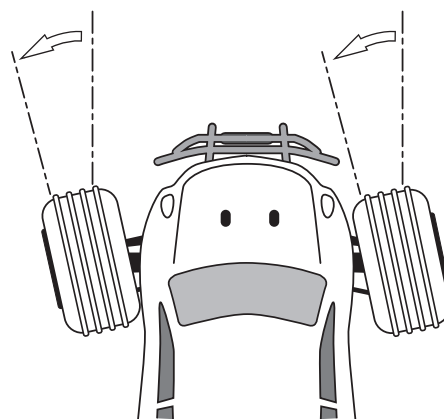

INDICATEUR LED :

- Lorsque vous utilisez les boutons de réglage du trim, la LED clignote lentement pour un appui court et rapidement pour un appui long.
- Quand la valeur du trim est au maximum la LED ne clignote pas.

8. INVERSE DU SENS DE ROTATION DE LA DIRECTION ET DE L'ACCÉLÉRATEUR

Inversion de la direction:

Pour changer le sens de rotation de la direction, montez le bouton « ST R/N » pendant quelques secondes jusqu'à entendre un « BIP » sonore, relâchez ensuite le bouton.

Inversion de l'accélérateur:

Cette fonction permet de changer le sens de rotation de l'accélération.

Si le bouton est en bas celle-ci est le sens normal tandis que si il est en haut, elle sera inversée.





S'IL VOUS PLAÎT NOTE

IMPORTANT : Veuillez noter que ce véhicule n'est pas étanche et ne doit pas être exécuté dans des conditions mouillées ou humides où l'humidité pourrait pénétrer dans l'électronique.

Arrêt du modèle

Eteignez l'interrupteur du récepteur (voiture), éteignez ensuite l'interrupteur de la radio-commande puis repliez l'antenne. Débranchez ensuite les batteries et retirez celles-ci de la voiture.

Laissez les batteries refroidir avant des les recharger. Si vous possédez une seconde batterie déjà chargée, laissez le véhicule refroidir quelques minutes avant d'installer cette deuxième batterie.

Entretien.

Vérifiez souvent que des vis ne sont pas absentes ou dévissées. Utilisez du frein filet pour tout remplacement de vis dans du métal. Vérifiez que les pièces en rotation sont bien libres (herbe , pierre etc). Si ces pièces ne sont pas libres cela peut les endommager ou encore user le moteur ou le variateur. Enlevez les roues et vérifiez que rien ne s'est glissé derrière l'hexagone de roue et n'empêche une bonne liberté de la transmission. Si le moteur bouge ou est enlevé pour entretien/échange, vous devez refaire le réglage de l'entre dents. Pour cela devisez les vis moteur et bougez-le jusqu'à avoir un petit jeu fonctionnel entre le pignon moteur et la couronne. Si ce réglage est mal fait la transmission peut être bruyante mais aussi s'endommager. Les amortisseurs vont s'user plus vite si vous roulez dans des conditions poussiéreuses, remplacez l'huile ainsi que les joints pour conservé un bon amortissement.

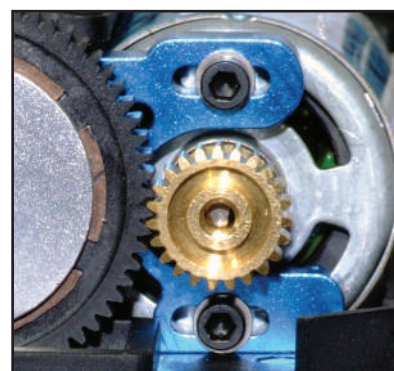

Solutions aux problèmes:

Durée de roulage très courte:	Vitesse lente:	Le moteur ou le variateur surchauffe:	Le moteur tourne mais la voiture n'avance pas:	Une portée courte ou aucun contrôle de la voiture:
Les batteries sont endommagées ou mal chargées.	Le moteur est sale ou les charbons usés.	La transmission n'est pas libre	La transmission est abîmée.	Les piles de la télécommande sont vides, les batteries de la voiture sont vides, l'antenne n'est pas dépliée, un fil est débranché, l'électronique est endommagée.
Le moteur est sale ou les charbons usés.		Le moteur est endommagé.	Le slipper est desserré, un cardant est cassé ou manquant.	

Garantie

De part la nature de ce produit et l'utilisation potentiel, FTX garanti qu'il n'a pas défaut lorsque le modèle est neuf. FTX s'engage à réparer ou remplacer les composants défectueux gratuitement dans un délai de 30 jours à compter de la date d'achat. Cette garantie ne couvre pas l'usure normale, l'accident ou l'impact, les modifications, les dégâts des eaux (appareil n'étant pas étanche) le manque d'entretien ou de dommages causés par une mauvaise utilisation. La preuve de la date d'achat sera nécessaire lors des réclamations de garantie.

Instructions pour la mise au rebut.

Ce produit ne doit pas être jeté avec les autres déchets. L'utilisateur doit le déposer dans un point de collecte et de recyclage des déchets. Pour plus d'informations sur l'endroit où vous pouvez déposer vos déchets, s'il vous plaît contacter votre municipalité, ou bien où vous avez acheté le produit.



CML DISTRIBUTION, SAXON HOUSE, SAXON BUSINESS PARK, HANBURY ROAD, BROMSGROVE, B60 4AD.





EXPLODED PARTS DIAGRAM

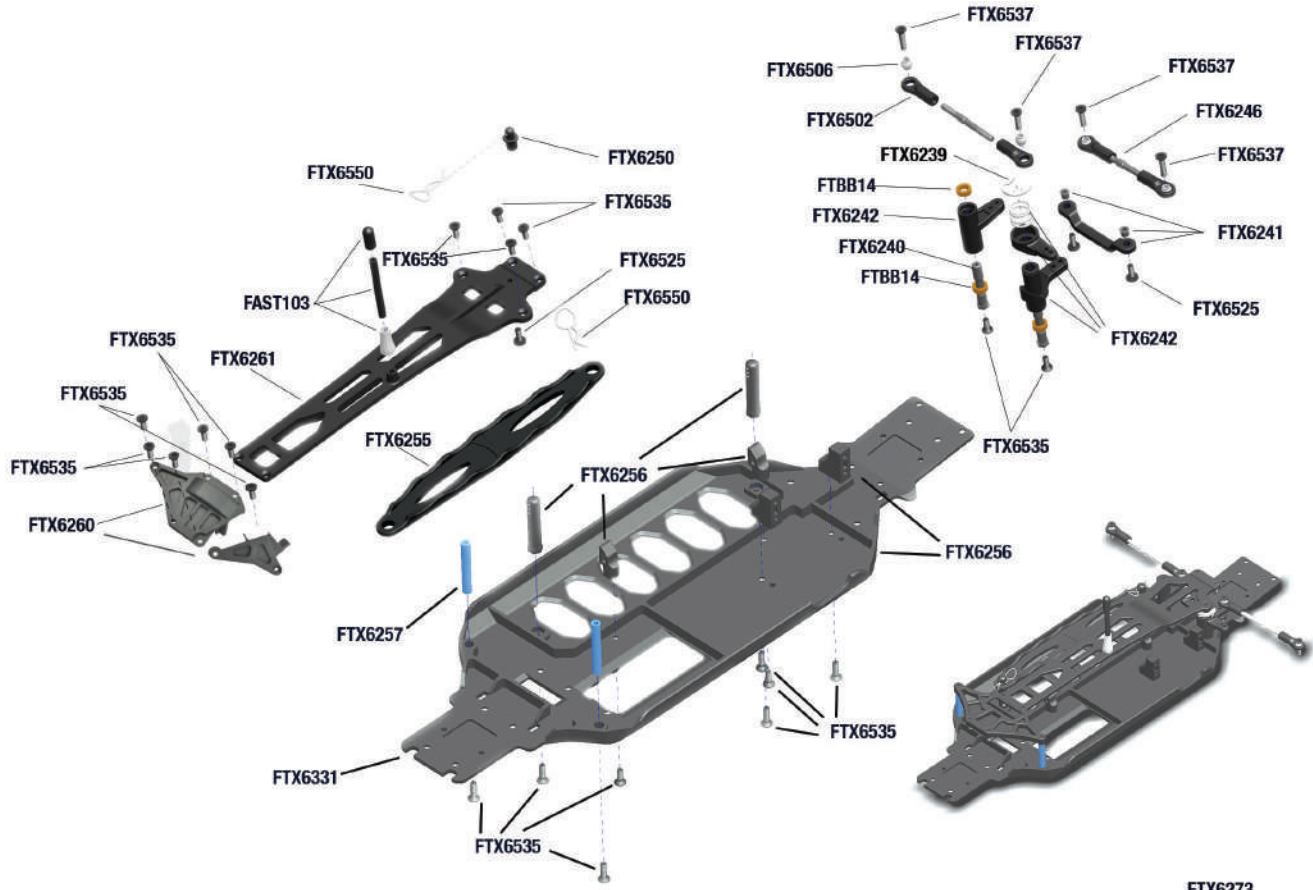

REAR ASSEMBLY



CENTRE DRIVE & MOTOR ASSEMBLY

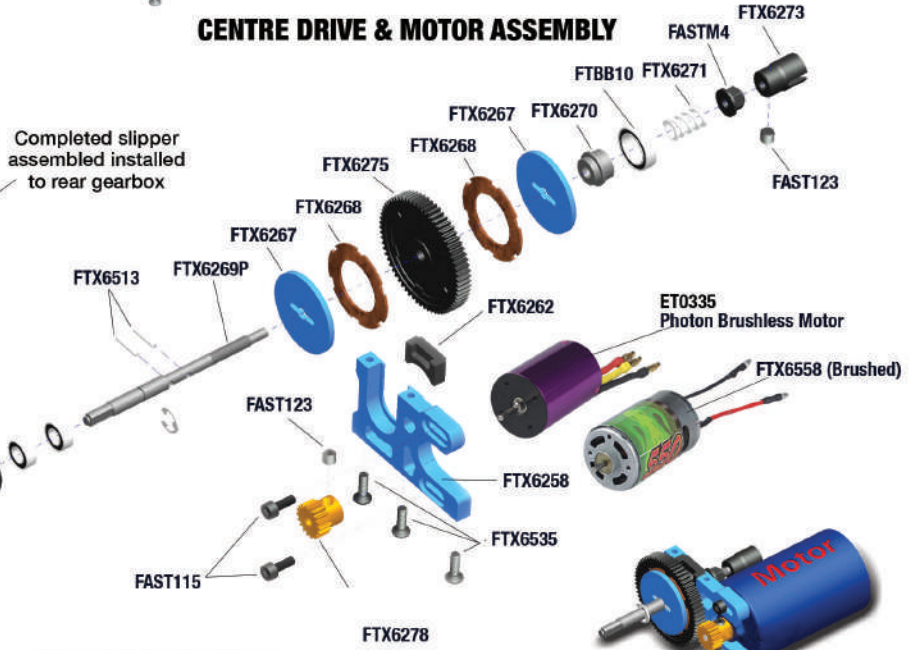

ESC



STEERING ASSEMBLY

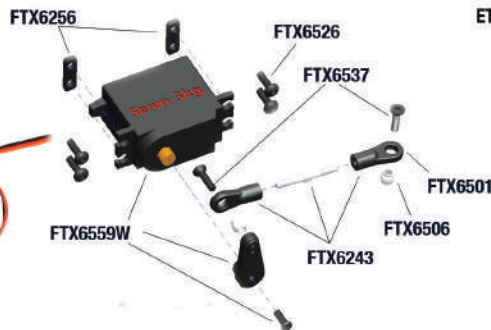

ET1152 Brushed RX

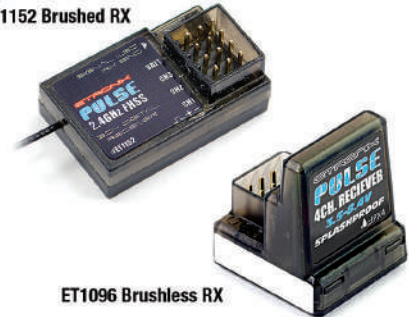



EXPLODED PARTS DIAGRAM

FRONT & REAR SHOCK ASSEMBLY

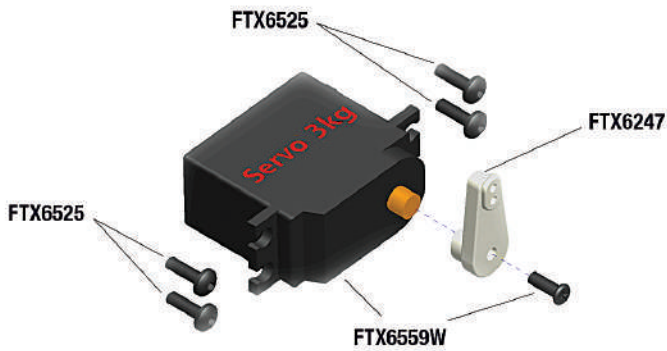
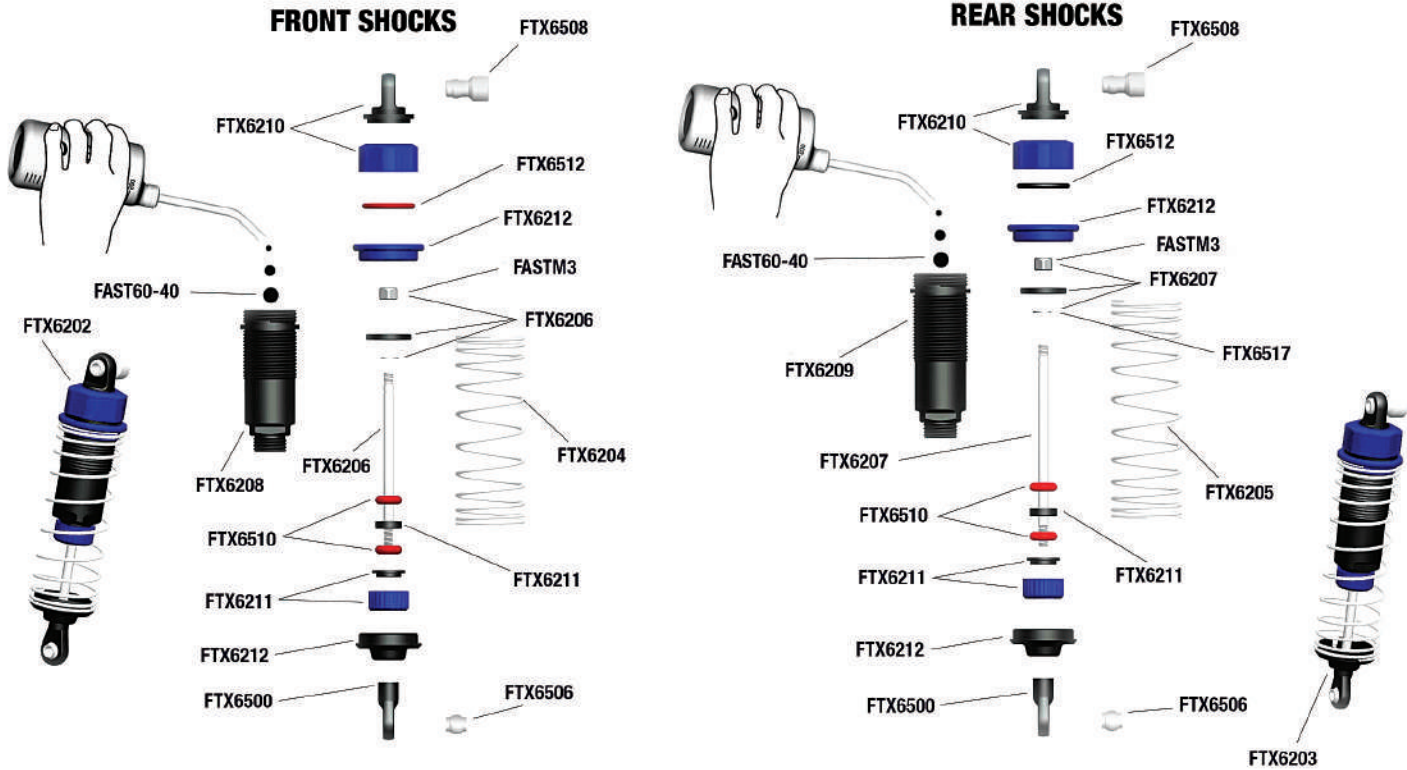

STEERING SERVO

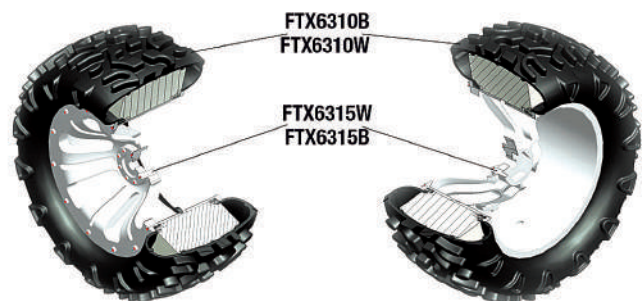
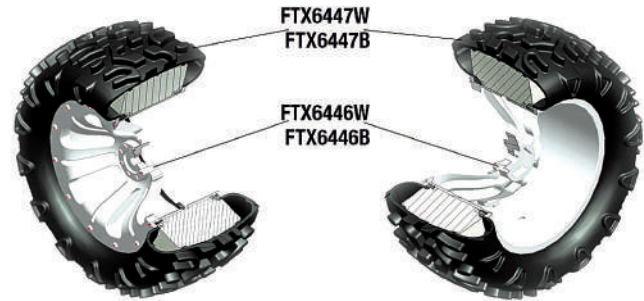



SPARE PARTS LIST

FTX6200	FTX6201	FTX6202	FTX6203
			
Front Shock Tower 1pc	Rear Shock Tower 1pc	Front Shocks 2pcs	Rear Shocks 2pcs
FTX6204	FTX6205	FTX6206	FTX6207
			
Front Shock Spring 2pcs	Rear Shock Spring 2pcs	Front Shock Shaft & Piston Set 2 sets	Rear Shock Shaft & Piston Set 2 sets
FTX6208	FTX6209	FTX6210	FTX6211
			
Front Shock Body 2pcs	Rear Shock Body 2pcs	Shock Upper Cap 2 Sets	Shock Lower Cap 2 Sets
FTX6212	FTX6215	FTX6216	FTX6217
			
Shock Lower Holder & Adjust Ring 2 sets	Steering Knuckle Arms 2 sets	Hub Carrier Uprights 2pcs	Hub Carrier Uprights 2pcs
FTX6213	FTX6220	FTX6221	FTX6225
			
Rear Drive Axles 2pcs	Front Suspension Holders 2pcs	Rear Suspension Holders 2pcs	Gearbox Housing Set 2pcs



SPARE PARTS LIST

<p>FTX6226</p>  <p>Diff. 16T Gear Washer 6pcs</p>	<p>FTX6227</p>  <p>Diff. Gear w/pin 2 sets</p>	<p>FTX6236</p>  <p>Diff. Gearbox Set 1 set</p>	<p>FTX6228</p>  <p>Diff. Case 2pcs</p>
<p>FTX6229</p>  <p>Diff. Drive Spur Gear</p>	<p>FTX6230</p>  <p>Diff. Drive Gear 2pcs</p>	<p>FTX6231</p>  <p>Diff. Bevel Gear S. 4pcs</p>	<p>FTX6232</p>  <p>Diff. Bevel Gear B. 4pcs</p>
<p>FTX6233</p>  <p>Diff. Pin 2pcs</p>	<p>FTX6234</p>  <p>Washer 6pcs</p>	<p>FTX6235</p>  <p>Diff. Drive Cup</p>	<p>FTX6237</p>  <p>Center Coupler 3pcs</p>
<p>FTX6240</p>  <p>Servo Saver Posts 2pcs</p>	<p>FTX6241</p>  <p>Steering Ackerman</p>	<p>FTX6224</p>  <p>Wheel Hub 4pcs</p>	<p>FTX6310C</p>  <p>Carnage Mounted Wheel/Tyre (pr) Chrome</p>
<p>FTX6310W</p>  <p>Carnage Mounted Rear Wheel/Tyre (pr) White</p>	<p>FTX6310B</p>  <p>Carnage Mounted Wheel/Tyre (pr) Black</p>	<p>FTX6315W</p>  <p>Carnage Mounted Wheel/Tyre (pr) White</p>	<p>FTX6315B</p>  <p>Carnage Wheels (pr) White</p>



SPARE PARTS LIST

<p>FTX6322</p>  <p>Front CVD 2 Sets</p>	<p>FTX6324N</p>  <p>Front Bumper & Brace</p>	<p>FTX6321</p>  <p>Rear Lower Susp. Arms 2pcs</p>	<p>FTX6320</p>  <p>Front Lower Susp. Arms 2pcs</p>
<p>FTX6345C</p>  <p>Carnage 2.0 Clear Body</p>	<p>FTX6345BKP</p>  <p>Carnage 2.0 Brushless Printed Body Black/Purple</p>	<p>FTX6345B</p>  <p>Carnage 2.0 Printed Body Blue</p>	<p>FTX6345R</p>  <p>Carnage 2.0 Printed Body Red</p>
<p>FTX6330 FTX6327</p>  <p>Servo Linkage 1pc</p> <p>Upper Front Susp. Arm 2 sets</p>	<p>FTX6328</p>  <p>Rear Upper Arm 2 sets</p>	<p>FTX6329</p>  <p>Steering Arm 2 sets</p>	<p>FTX6323</p>  <p>Rear Dogbone F. 1pc</p>
<p>FTX6255</p>  <p>Battery Cover (EP) 1pc</p>	<p>FTX6256</p>  <p>Battery Posts 2 sets</p>	<p>FTX6257</p>  <p>Rear Spur Gear Cover Post 2pc</p>	<p>FTX6258</p>  <p>Motor Mount (EP) 1pc</p>
<p>FTX6266</p>  <p>Slipper Complete (EP) 1 set</p>	<p>FTX6267</p>  <p>Slipper Pad (EP) 2pcs</p>	<p>FTX6268</p>  <p>Slipper Gasket (EP) 2pcs</p>	<p>FTX6275</p>  <p>Spur Gear (EP) 65T 1pc</p>



SPARE PARTS LIST

FTX6269P  Slipper Shaft (EP) 1 set	FTX6270  Slipper Spring Bracket (EP) 1pc	FTX6271  Slipper Spring (EP) 1pc	FTX6326  Servo Saver (EP) 1 set
FTX6273  Slipper Drive Cup 1pc	FTX6262  Bearing Bracket (EP) 1pc	FTX6335  Pinion Gear (EP) 17T 1pc	FTX6948  Front and Rear Body Mounts
FTX6331  Chassis Plate (EP) 1pc	FTX6260  Rear Spur Gear Cover (EP) 1pc	FTX6333  Upper Plate (EP) 1pc	FTX6334  Center Drive Shaft (EP) 1pc
FTX6550  Body Clip (med) 6pcs	FTX6551  Body Clip (small) 6pcs	FTX6500  Shock Ball End 6pcs	FTX6501  Servo link Ball End 6pcs
FTX6502  Steering Link Ball End 6pcs	FTX6503  Rear Upper Link Ball End 6pcs	FTX6504  Sway Bar Fix Plate 6pcs	FTX6505  Sway Bar Holders 6pcs























SPARE PARTS LIST

<p>FTX6506</p>  <p>Ball A 6pcs</p>	<p>FTX6507</p>  <p>Ball B 6pcs</p>	<p>FTX6508</p>  <p>Ball C 6pcs</p>	<p>FTX6509</p>  <p>Ball D 6pcs</p>
<p>FTX6510</p>  <p>Shock O-Ring Lower 6pcs</p>	<p>FTX6511</p>  <p>Diff. O-Ring Seal 6pcs</p>	<p>FTX6512</p>  <p>Shock O-Ring Upper 6pcs</p>	<p>FTX6513</p>  <p>Pin 2x10 6pcs</p>
<p>FTX6514</p>  <p>Pin 2x11 6pcs</p>	<p>FTX6223</p>  <p>Hinge Pins (long & short) 1set</p>	<p>FTBB10</p>  <p>Ball Bearing 15x10x4 1pc</p>	<p>FTBB120</p>  <p>Ball Bearing 10x5x4 1pc</p>
<p>FTBB14</p>  <p>Ball Bearing 8x5x2.5 1pc</p>	<p>FTX6239</p>  <p>E-Clip 8mm 4pcs</p>	<p>FTX6516</p>  <p>E-Clip 4mm 4pcs</p>	<p>FTX6517</p>  <p>E-Clip 2.5mm 6pcs</p>
<p>FASTM3</p>  <p>Ny-Lock Nut M3 6pcs</p>	<p>FASTM4</p>  <p>Ny-Lock Nut M4 6pcs</p>	<p>FTX6518</p>  <p>Round Head Self-Tapping Hex Screw 2x10 6pcs</p>	<p>FTX6519</p>  <p>Round Head Self-Tapping Hex Screw 2x10 6pcs</p>















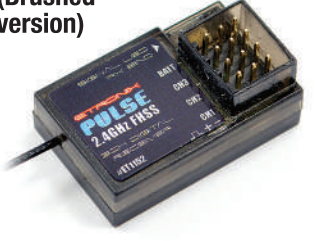

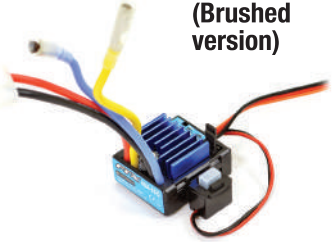
SPARE PARTS LIST

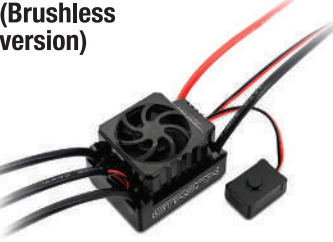
<p>FTX6520</p>  <p>Round Head Self-Tapping Hex Screw 3x12 6pcs</p>	<p>FTX6522</p>  <p>Round Head Self-Tapping Hex Screw M3x6 6pcs</p>	<p>FTX6525</p>  <p>Button Head Hex Screw M3x8 6pcs</p>	<p>FTX6526</p>  <p>Button Head Hex Screw M3x10 6pcs</p>
<p>FTX6527</p>  <p>Button Head Hex Screw M3x12 6pcs</p>	<p>FTX6528</p>  <p>Button Head Hex Screw M3x14 6pcs</p>	<p>FTX6530 FTX6531</p>  <p>Ring Self-Tapping Screw 3x6 6pcs Ring Self-Tapping Screw 3x6 4pcs</p>	<p>FAST122</p>  <p>Set Screw M3x3 6pcs</p>
<p>FAST123</p>  <p>Set Screw M4x4 6pcs</p>	<p>FTX6543</p>  <p>Button Head Hex Screw M4x10 6pcs</p>	<p>FAST114</p>  <p>Cap Head Hex Screw M3x8 6pcs</p>	<p>FTX6542</p>  <p>Cap Head Hex Screw M3x10 6pcs</p>
<p>FAST115</p>  <p>Cap Head Hex Screw M3x10 6pcs</p>	<p>FTX6532</p>  <p>Cap Head Hex Screw M3x14 6pcs</p>	<p>FAST117</p>  <p>Cap Head Hex Screw M3x15 6pcs</p>	<p>FAST118</p>  <p>Cap Head Hex Screw M3x18 6pcs</p>
<p>FAST119</p>  <p>Cap Head Hex Screw M3x25 6pcs</p>	<p>FTX6533</p>  <p>Cap Head Hex Screw M3x28 6pcs</p>	<p>FTX6535</p>  <p>Flat Head Hex Screw M3x8 6pcs</p>	<p>FTX6536</p>  <p>Flat Head Hex Screw M3x10 6pcs</p>

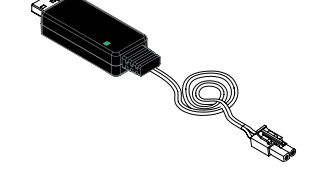

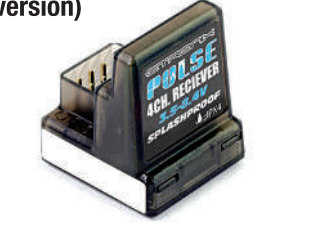
SPARE PARTS LIST

<p>FTX6537</p>  <p>Flat Head Hex Screw M3x12 6pcs</p>	<p>FTX6538</p>  <p>Flat Head Hex Screw M3x14 6pcs</p>	<p>FTX6539</p>  <p>Flat Head Hex Screw M3x18 3pcs</p>	<p>FTX6540</p>  <p>Flat Head Hex Screw M2x20 6pcs</p>
<p>FTX6541</p>  <p>Flat Head Hex Screw M3x36 6pcs</p>	<p>ET1152 (Brushed version)</p>  <p>2.4ghz Receiver</p>	<p>ET1106 (Brushed version)</p>  <p>2.4GHz Transmitter & Rx 1set</p>	<p>VZ0010</p>  <p>Ni-MH 7.2V 1800mAh 1pc</p>
<p>FTX6557W2 (Brushed version)</p>  <p>60A Waterproof ESC 1pc</p>	<p>FTX6559W</p>  <p>3kg/cm Servo 1pc</p>	<p>FTX6558</p>  <p>550 Motor Brushed 1pc</p>	<p>ET0132FTX (Brushless version)</p>  <p>Photon 3.0 50 Amp</p>
<p>ET0335 (Brushless version)</p>  <p>2950kv Brushless Motor 1pc</p>	<p>VZ0305 (Brushless version)</p>  <p>Li-Po 3200mAh 7.4V Cell Pack 1pc</p>	<p>ET0226T (Brushed version)</p>  <p>USB Charger for NiMH Battery</p>	<p>ET0223 (Brushless version)</p>  <p>Li-Po Balance Charger</p>
<p>ET1061 (Brushless version)</p>  <p>Pulse EX4P 4CH TX</p>	<p>ET1096 (Brushless version)</p>  <p>Pulse 4ch Receiver</p>	<p>FTX6346</p>  <p>Front Bumper LED Lights</p>	

CARNAGE

BRUSHLESS 2.0



www.ftx-rc.com



FTX is an exclusive brand of CML Distribution, Saxon House, Saxon Business Park,
Hanbury Road, Bromsgrove, Worcestershire, B60 4AD England.
E-mail: info@ftx-rc.com